



AUSTRALIAN
DESIGNED & MADE
PRIMARY
SALES AUSTRALIA

HARVEST DEALER GUIDE 2020



EXCLUSIVE

BUSHEL PLUS™
HARVEST LOSS
CALIBRATION SYSTEM
MORE INFO PAGE 22

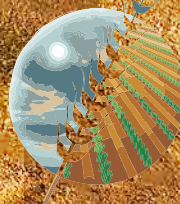

PRIMARY
SALES AUSTRALIA



WELCOME TO PRIMARY SALES HARVEST DEALER GUIDE 2020

You will notice that we have included "Knife Guard Kits" as well as the new product "Bushel Plus" for the 2020 harvest season. (See page 22 for Bushel Plus).

We have created "Knife Guard Kits" (e.g. FK-CA2142-4-DD40) to help you order the right parts for your header front. The Knife Guard Kit including the correct number of main guards (e.g. FB-40M) and all the special guards you require specific to your header (brand, model, size and whether it is single or dual knife). Captured as a "Knife Guard Kit" product code (e.g. FK-CA2142-4-DD40).

ONCE YOU'VE FOUND THE PAGE FOR YOUR BRAND OF HEADER/ HARVESTER -

1 DECIDE ON NUMBER OF FINGERS ON GUARD (4, 3 OR 2 WHERE AVAILABLE) FOR LIGHT, MEDIUM OR HEAVY CROP.

2 LOCATE THE MODEL NUMBER OF HEADER FRONT EG MACDON D60. AND IF SINGLE OR DUAL KNIFE.

3 FIND THE WIDTH OF HEADER FRONT THAT MATCHES YOURS. YOU WILL NEED TO SELECT THE RELEVANT GUARD KIT NUMBER TO ORDER (FK-MAD60-4-DS40) THIS HAS ALL THE KNIFE GUARDS YOU NEED).

4 IF YOU DON'T REQUIRE A LIFT KIT (WHICH INCLUDES LONGER BOLT), BUT YOU NEED BOLTS, YOU WILL NEED TO ORDER MATCHING BOLT KIT (EG FK-MACD60-BK40). YOU'RE READY TO ORDER.

5 IF YOU NEED A LIFT KIT SELECT THE LIFT KIT ON THE SAME LINE AS YOUR IDENTIFIED GUARD KIT EG, FK-MAD60-LK40. YOU WILL NOT NEED THE BOLT KIT AS LIFT KIT INCLUDES CORRECT BOLTS.

6 YOU CAN ALSO ADD CEREAL EXTENSIONS (FE13/17/21) OR PLATFORM EXTENDERS (FE50-W-A) TO REDUCE GRAIN LOSS. PRICE IS FOR FULL SET TO MATCH YOUR HEADER FRONT. YOU'RE READY TO ORDER.

MacDon ADAPT-A-GAP™ CROP FINGER SYSTEM

LIGHT CROPS (4 FINGER GUARDS)

Size	Kit	Kit Price	Bolt kit (guard only)	Bolt Kit Price	Lift Kit (with bolts)	Lift Kit Price	Cereal Ext	Platform Ext
MACDON D60 Draper Single (Kit incl. FB-40M plus drive end guards FB-4-M, FB-4-M-KH, FB-4-3M-KHL)								
30	FK-MAD60-4-DS30	\$3,549	FK-MAD60-BK30	\$698	FK-MAD60-LK30	\$1,279	FE 13/17/21 \$1,063	FE 50-W-A \$4,449
35	FK-MAD60-4-DS35	\$4,144	FK-MAD60-BK35	\$818	FK-MAD60-LK35	\$1,437	\$1,236	\$5,183
40	FK-MAD60-4-DS40	\$4,739	FK-MAD60-BK40	\$938	FK-MAD60-LK40	\$1,594	\$1,410	\$5,917
MACDON D60 Draper Dual (Kit incl. FB-40M plus drive end guards FB-4-M, FB-4-M-KH, FB-40M-KOC, FB-4-3M-KHL)								
40	FK-MAD60-4-DD40	\$4,783	FK-MAD60-BK40	\$938	FK-MAD60-LK40	\$1,594	\$1,410	\$5,917
45	FK-MAD60-4-DD45	\$5,378	FK-MAD60-BK45	\$1,031	FK-MAD60-LK45	\$2,121	\$1,583	\$6,650

MacDon ADAPT-A-GAP™ CROP FINGER SYSTEM

LIGHT CROPS (4 FINGER GUARDS)

Size	Kit	Kit Price	Bolt kit (guard only)	Bolt Kit Price	Lift Kit (with bolts)	Lift Kit Price	Cereal Ext	Platform Ext
MACDON D60 Draper Single (Kit incl. FB-40M plus drive end guards FB-4-M, FB-4-M-KH, FB-4-3M-KHL)								
30	FK-MAD60-4-DS30	\$3,549	FK-MAD60-BK30	\$698	FK-MAD60-LK30	\$1,279	FE 13/17/21 \$1,063	FE 50-W-A \$4,449
35	FK-MAD60-4-DS35	\$4,144	FK-MAD60-BK35	\$818	FK-MAD60-LK35	\$1,437	\$1,236	\$5,183
40	FK-MAD60-4-DS40	\$4,739	FK-MAD60-BK40	\$938	FK-MAD60-LK40	\$1,594	\$1,410	\$5,917
MACDON D60 Draper Dual (Kit incl. FB-40M plus drive end guards FB-4-M, FB-4-M-KH, FB-40M-KOC, FB-4-3M-KHL)								
40	FK-MAD60-4-DD40	\$4,783	FK-MAD60-BK40	\$938	FK-MAD60-LK40	\$1,594	\$1,410	\$5,917
45	FK-MAD60-4-DD45	\$5,378	FK-MAD60-BK45	\$1,031	FK-MAD60-LK45	\$2,121	\$1,583	\$6,650

ORDER:

GUARD KIT
FK-MAD60-D-DS40



BOLT KIT
FK-MAD60-BK40

MacDon ADAPT-A-GAP™ CROP FINGER SYSTEM

LIGHT CROPS (4 FINGER GUARDS)

Size	Kit	Kit Price	Bolt kit (guard only)	Bolt Kit Price	Lift Kit (with bolts)	Lift Kit Price	Cereal Ext	Platform Ext
MACDON D60 Draper Single (Kit incl. FB-40M plus drive end guards FB-4-M, FB-4-M-KH, FB-4-3M-KHL)								
30	FK-MAD60-4-DS30	\$3,549	FK-MAD60-BK30	\$698	FK-MAD60-LK30	\$1,279	FE 13/17/21 \$1,063	FE 50-W-A \$4,449
35	FK-MAD60-4-DS35	\$4,144	FK-MAD60-BK35	\$818	FK-MAD60-LK35	\$1,437	\$1,236	\$5,183
40	FK-MAD60-4-DS40	\$4,739	FK-MAD60-BK40	\$938	FK-MAD60-LK40	\$1,594	\$1,410	\$5,917
MACDON D60 Draper Dual (Kit incl. FB-40M plus drive end guards FB-4-M, FB-4-M-KH, FB-40M-KOC, FB-4-3M-KHL)								
40	FK-MAD60-4-DD40	\$4,783	FK-MAD60-BK40	\$938	FK-MAD60-LK40	\$1,594	\$1,410	\$5,917
45	FK-MAD60-4-DD45	\$5,378	FK-MAD60-BK45	\$1,031	FK-MAD60-LK45	\$2,121	\$1,583	\$6,650

ORDER WITH LIFT KIT AND CEREAL EXTENSIONS:

GUARD KIT
FK-MAD60-D-DS40



LIFT KIT
FK-MAD60-LK40



CEREAL EXT
\$1,410

NEED HELP? PLEASE CALL (08) 9250 3500



JOHN DEERE ADAPT-A-GAP™ CROP FINGER SYSTEM



ALLROUNDER (3 FINGER GUARDS)

Size	Kit	Kit Price	Bolt kit (guard only)	Bolt Kit Price	Lift Kit (with bolts)	Cereal Ext	Cereal Ext	Platform Ext
JOHN DEERE 900 Rigid Single Knife (Kit incl. FG-3JD-TM)						FE 13/17/21	FE-30W/30W-3	FE 65W-A
25	FK-JD900-3-RS25	\$3,040	No Bolt Kit		No Lift Kit	\$693	\$854	\$3,641
30	FK-JD900-3-RS30	\$3,648	No Bolt Kit		No Lift Kit	\$857	\$1,019	\$4,359
36	FK-JD900-3-RS36	\$4,378	No Bolt Kit		No Lift Kit	\$961	\$1,218	\$5,222

JOHN DEERE 600R Series Single Knife (US Build) (Kit incl. FG-3JD-TM)

Size	Kit	Kit Price	Bolt kit (guard only)	Bolt Kit Price	Lift Kit (with bolts)	Cereal Ext	Cereal Ext	Platform Ext
JOHN DEERE 600R Series Single Knife (US Build) (Kit incl. FG-3JD-TM)						FE 13/17/21	FE-30W/30W-3	FE 65W-A
22	FK-JD600RU-3-RS22	\$2,675	No Bolt Kit		No Lift Kit	\$613	\$754	\$3,211
25	FK-JD600RU-3-RS25	\$3,040	No Bolt Kit		No Lift Kit	\$693	\$854	\$3,641
30	FK-JD600RU-3-RS30	\$3,648	No Bolt Kit		No Lift Kit	\$857	\$1,019	\$4,359
36	FK-JD600RU-3-RS36	\$4,378	No Bolt Kit		No Lift Kit	\$961	\$1,218	\$5,222

JOHN DEERE 600F Series Single Flex (US Build)(Kit incl. FG-3JD-TM)

Size	Kit	Kit Price	Bolt kit (guard only)	Bolt Kit Price	Lift Kit (with bolts)	Cereal Ext	Cereal Ext	Platform Ext
JOHN DEERE 600F Series Single Flex (US Build)(Kit incl. FG-3JD-TM)						FE 13/17/21	FE-30W/30W-3	FE 65W-A
22	FK-JD600F-3-FS22	\$2,675	No Bolt Kit		No Lift Kit	\$613	\$754	\$3,211
25	FK-JD600F-3-FS25	\$3,040	No Bolt Kit		No Lift Kit	\$693	\$854	\$3,641
30	FK-JD600F-3-FS30	\$3,648	No Bolt Kit		No Lift Kit	\$857	\$1,019	\$4,359
36	FK-JD600F-3-FS36	\$4,378	No Bolt Kit		No Lift Kit	\$961	\$1,218	\$5,222

JOHN DEERE 600D Series Dual Knife (Kit incl. FG-3JD-TM, FG-3JD-KH, FG-3JD-KH-LH, FG-3JD-KH-RH, FG-3JD-KOC)

Size	Kit	Kit Price	Bolt kit (guard only)	Bolt Kit Price	Lift Kit (with bolts)	Cereal Ext	Cereal Ext	Platform Ext
JOHN DEERE 600D Series Dual Knife (Kit incl. FG-3JD-TM, FG-3JD-KH, FG-3JD-KH-LH, FG-3JD-KH-RH, FG-3JD-KOC)						FE 13/17/21	FE-30W/30W-3	FE 65W-A
35	FK-JD635D-3-DD35	\$4,422	No Bolt Kit	FK-JD635D-LK35 \$2,145		\$961	\$1,185	\$5,078
40	FK-JD640D-3-DD40	\$5,030	No Bolt Kit	FK-JD640D-LK40 \$2,294		\$1,095	\$1,351	\$5,796

JOHN DEERE 700D Series Dual Knife (Kit incl. FG-3JD-TM, FG-3JD-KH, FG-3JD-KH-LH, FG-3JD-KH-RH, FG-3JD-KOC)

Size	Kit	Kit Price	Bolt kit (guard only)	Bolt Kit Price	Lift Kit (with bolts)	Cereal Ext	Cereal Ext	Platform Ext
JOHN DEERE 700D Series Dual Knife (Kit incl. FG-3JD-TM, FG-3JD-KH, FG-3JD-KH-LH, FG-3JD-KH-RH, FG-3JD-KOC)						FE 13/17/21	FE-30W/30W-3	FE 65W-A
35	FK-JD735D-3-DD35	\$4,422	No Bolt Kit	FK-JD735D-LK35 \$2,145		\$961	\$1,185	\$5,078
40	FK-JD740D-3-DD40	\$5,030	No Bolt Kit	FK-JD740D-LK40 \$2,294		\$1,095	\$1,351	\$5,796
45	FK-JD745D-3-DD45	TBA		FK-JD745D-LK45 TBA				

JOHN DEERE 700F Series Dual Knife (Kit incl. FG-3JD-TM, FG-3JD-KH, FG-3JD-KH-LH, FG-3JD-KH-RH, FG-3JD-KOC)

Size	Kit	Kit Price	Bolt kit (guard only)	Bolt Kit Price	Lift Kit (with bolts)	Cereal Ext	Cereal Ext	Platform Ext
JOHN DEERE 700F Series Dual Knife (Kit incl. FG-3JD-TM, FG-3JD-KH, FG-3JD-KH-LH, FG-3JD-KH-RH, FG-3JD-KOC)						FE 13/17/21	FE-30W/30W-3	FE 65W-A
35	FK-JD735F-3-DD35	TBA		FK-JD735F-LK35 TBA		TBA		
40	FK-JD740F-3-DD40	TBA		FK-JD740F-LK40 TBA		TBA		
45	FK-JD745F-3-DD45	TBA		FK-JD745F-LK45 TBA		TBA		

LIGHT CROPS (4 FINGER GUARDS)

JOHN DEERE 200 Series Single knife (Kit incl. FB-3 plus Drive End Guard FB-35-5)

Size	Kit	Kit Price	Bolt kit (guard only)	Bolt Kit Price	Lift Kit (with bolts)	Cereal Ext	Cereal Ext	Platform Ext
JOHN DEERE 200 Series Single knife (Kit incl. FB-3 plus Drive End Guard FB-35-5)						FE 13/17/21	FE 50-W-A	
24	FK-JD200-4-RS24	\$3,972	No Bolt Kit		No Lift Kit	\$880	\$3,676	
30	FK-JD200-4-RS30	\$4,948	No Bolt Kit		No Lift Kit	\$1,095	\$4,583	
36	FK-JD200-4-RS36	\$5,925	No Bolt Kit		No Lift Kit	\$1,310	\$5,490	

JOHN DEERE 900 Series Single knife (Kit incl. FB-3 plus Drive End Guard FB-35-5 - hardware kit of LHDACL P required)

Size	Kit	Kit Price	Bolt kit (guard only)	Bolt Kit Price	Lift Kit (with bolts)	Cereal Ext	Cereal Ext	Platform Ext
JOHN DEERE 900 Series Single knife (Kit incl. FB-3 plus Drive End Guard FB-35-5 - hardware kit of LHDACL P required)						FE 13/17/21	FE 50-W-A	
24	FK-JD900-4-RS24	\$3,972	FK-JD900-BK24	\$274	No Lift Kit	\$880	\$3,676	
30	FK-JD900-4-RS30	\$4,948	FK-JD900-BK30	\$342	No Lift Kit	\$1,095	\$4,583	
36	FK-JD900-4-RS36	\$5,925	FK-JD900-BK36	\$410	No Lift Kit	\$1,310	\$5,490	

JOHN DEERE 900F Series Single Flex (Kit incl. FB-3 plus FB-3-JDFF at skid plates plus FB-32-3, FB-37-6)

Size	Kit	Kit Price	Bolt kit (guard only)	Bolt Kit Price	Lift Kit (with bolts)	Cereal Ext	Cereal Ext	Platform Ext
JOHN DEERE 900F Series Single Flex (Kit incl. FB-3 plus FB-3-JDFF at skid plates plus FB-32-3, FB-37-6)						FE 13/17/21	FE 50-W-A	
30	FK-JD930F-4-FS30	\$5,154	No Bolt Kit		No Lift Kit	\$1,095	\$4,583	

JOHN DEERE 600 Rigid Single Knife (European Build using Schumacher Guards) (Kit incl. FG-5 and hardware) (30 ft requires OEM knife Head JDPN AXE35 145 - suits JD635R)

Size	Kit	Kit Price	Bolt kit (guard only)	Bolt Kit Price	Lift Kit (with bolts)	Cereal Ext	Cereal Ext	Platform Ext
JOHN DEERE 600 Rigid Single Knife (European Build using Schumacher Guards) (Kit incl. FG-5 and hardware) (30 ft requires OEM knife Head JDPN AXE35 145 - suits JD635R)						FE 13/17/21	FE-30W/30W-3	FE 65W-A
30	FK-JD600RE-3-RS30	\$4,139	No Bolt Kit		No Lift Kit	\$829	\$950	\$4,359
35	FK-JD600RE-3-RS35	\$4,802	No Bolt Kit		No Lift Kit	\$961	\$1,083	\$5,078





10 SERIES
FRONTS
ALSO
SUPPORTED



LIGHT CROPS (4 FINGER GUARDS)

Size	Kit	Kit Price	Bolt kit (guard only)	Bolt Kit Price	Lift Kit (with bolts)	Lift Kit Price	Cereal Ext	Platform Ext
CASE 1042 Draper (Kit incl. FB-40M plus drive end guards FB-4-M, FB-4-3M)								
25	FK-CA1042-4-DS25	\$3,036	FK-CA1042-BK25	\$340	FK-CA1042-LK25	\$2,386	\$916	\$3,827
30	FK-CA1042-4-DS30	\$3,649	FK-CA1042-BK30	\$408	FK-CA1042-LK30	\$2,575	\$1,095	\$4,583
36	FK-CA1042-4-DS36	\$4,384	FK-CA1042-BK36	\$490	FK-CA1042-LK36	\$2,771	\$1,310	\$5,490
CASE 1052 Draper (Kit incl. FB-40M plus drive end guards FB-4-M, FB-4-3M) Req OEM Knife Head								
25	FK-CA1052-4-DS25	\$3,036	FK-CA1052-BK25	\$340	FK-CA1052-LK25	\$776	\$916	\$3,827
30	FK-CA1052-4-DS30	\$3,649	FK-CA1052-BK30	\$408	FK-CA1052-LK30	\$937	\$1,095	\$4,582
36	FK-CA1052-4-DS36	\$4,384	FK-CA1052-BK36	\$490	FK-CA1052-LK36	\$1,103	\$1,310	\$5,491
CASE 2010 Rigid (Kit incl. FB-40M, FB-43-3M, FB-46-4, FB-47-5-KOC, FB-48-4, FB-49-5)								
30	FK-CA2010-4-RD30	\$3,919	No Bolt Kit		No Lift Kit		\$1,095	\$4,582
35	FK-CA2010-4-RD35	\$4,532	No Bolt Kit		No Lift Kit		\$1,273	\$5,338
CASE 2020 Flex (Kit incl. FB-40M, FB-43-3M, FB-46-4, FB-47-5-KOC, FB-48-4, FB-49-5)								
30	FK-CA2020-4-FD30	\$3,919	No Bolt Kit		No Lift Kit		\$1,095	\$4,582
35	FK-CA2020-4-FD35	\$4,532	No Bolt Kit		No Lift Kit		\$1,273	\$5,338
CASE 2052 (Kit incl. FB-40M plus drive end guards FB-4-M, FB-4-M-KH, FB-4-3M-KHL)								
30	FK-CA2052-4-DS30	\$3,642	FK-CA2052-BK30	\$408	FK-CA2052-LK30	\$1,317	\$1,095	\$4,582
36	FK-CA2052-4-DS36	\$4,377	FK-CA2052-BK36	\$490	FK-CA2052-LK36	\$1,516	\$1,310	\$5,491
39	FK-CA2052-4-DS39	\$4,745	FK-CA2052-BK39	\$530	FK-CA2052-LK39	\$1,593	\$1,416	\$5,943
CASE 2142 Single Knife (Kit incl. FB-40M plus drive end guards FB-4-M, FB-4-M-KH, FB-4-3M-KHL)								
30	FK-CA2142-4-DS30	\$3,781	FK-CA2142-BK30	\$408	FK-CA2142-LK30	\$1,319	\$1,095	\$4,582
35	FK-CA2142-4-DS35	\$4,416	FK-CA2142-BK35	\$476	FK-CA2142-LK35	\$1,480	\$1,273	\$5,338
40	FK-CA2142-4-DS40	\$5,051	FK-CA2142-BK40	\$544	FK-CA2142-LK40	\$2,062	\$1,452	\$6,094
CASE 2142 Dual Knife (Kit incl. FB-40M plus drive end guards FB-4-M, FB-4-M-KH, FB-40M-KOC, FB-4-3M-KHL)								
40	FK-CA2142-4-DD40	\$5,103	FK-CA2142-BK40	\$544	FK-CA2142-LK40	\$2,062	\$1,452	\$6,094
45	FK-CA2142-4-DD45	\$5,738	FK-CA2142-BK45	\$612	FK-CA2142-LK45	\$2,190	\$1,631	\$6,849
CASE 2152 Single Knife (Kit incl. FB-40M plus drive end guards FB-4-M, FB-4-M-KH, FB-4-3M-KHL)								
30	FK-CA2152-4-DS30	\$3,781	FK-CA2152-BK30	\$408	FK-CA2152-LK30	\$1,319	\$1,095	\$4,582
35	FK-CA2152-4-DS35	\$4,416	FK-CA2152-BK35	\$476	FK-CA2152-LK35	\$1,480	\$1,273	\$5,338
40	FK-CA2152-4-DS40	\$5,051	FK-CA2152-BK40	\$544	FK-CA2152-LK40	\$2,062	\$1,452	\$6,094
CASE 2152 Dual Knife (Kit incl. FB-40M plus drive end guards FB-4-M, FB-4-M-KH, FB-40M-KOC, FB-4-3M-KHL)								
40	FK-CA2152-4-DD40	\$5,103	FK-CA2152-BK40	\$544	FK-CA2152-LK40	\$2,062	\$1,452	\$6,094
45	FK-CA2152-4-DD45	\$5,738	FK-CA2152-BK45	\$612	FK-CA2152-LK45	\$2,190	\$1,631	\$6,849
CASE 2162 Single Flex (Kit incl. FB-40M plus drive end guards FB-4-M, FB-4-M-KH, FB-4-3M-KHL)								
30	FK-CA2162-4-FS30	\$3,781	FK-CA2162-BK30	\$408	No Lift Kit		\$1,095	\$4,582
35	FK-CA2162-4-FS35	\$4,416	FK-CA2162-BK35	\$476	No Lift Kit		\$1,273	\$5,338
40	FK-CA2162-4-FS40	\$5,051	FK-CA2162-BK40	\$544	No Lift Kit		\$1,452	\$6,094
CASE 2162 Dual Flex (Kit incl. FB-40M plus drive end guards FB-4-M, FB-4-M-KH, FB-40M-KOC, FB-4-3M-KHL)								
40	FK-CA2162-4-FD40	\$5,103	FK-CA2162-BK40	\$544	No Lift Kit		\$1,452	\$6,094
45	FK-CA2162-4-FD45	\$5,738	FK-CA2162-BK45	\$612	No Lift Kit		\$1,631	\$6,849
CASE 3050 Varifeed Single (Kit incl. FB-40M plus drive end guards FB-42-M4, FB-49-5)								
30	FK-CA3050-4-DS30	\$3,948	No Bolt Kit		No Lift Kit		\$1,095	\$4,582
35	FK-CA3050-4-DS35	\$4,587	No Bolt Kit		No Lift Kit		\$1,285	\$5,338
CASE 3050 Varifeed Dual (Kit incl. FB-40M plus special guards FB-40M-KOC, FB-42-M4, FB-49-5 & V-HDCLIP)								
41	FK-CA3050-4-DD41	\$5,516	No Bolt Kit		No Lift Kit		\$1,488	\$6,094
CASE 3152 Dual Knife (Kit incl. FB-40M, FB-43-CD-LH, FB-44-CD-RH, FB-46-CD-KOC02, FB-4-M-KHC, FB-46-4)								
30	FK-CA3152-4-DD30	\$4,115	No Bolt Kit		FK-CA3152-LK30	\$2,780	\$1,095	\$4,690
35	FK-CA3152-4-DD35	\$4,749	No Bolt Kit		FK-CA3152-LK35	\$2,991	\$1,273	\$5,338
40	FK-CA3152-4-DD40	\$5,404	No Bolt Kit		FK-CA3152-LK40	\$3,147	\$1,452	\$6,094
45	FK-CA3152-4-DD45	\$6,039	No Bolt Kit		FK-CA3152-LK45	\$3,313	\$1,631	\$6,849
CASE 4152 Dual Knife (Kit incl. FB-40M, FB-43-CD-LH, FB-44-CD-RH, FB-46-CD-KOC02, FB-4-M-KHC, FB-46-4)								
30	FK-CA3152-4-DD30	\$4,115	No Bolt Kit		FK-CA3152-LK30	\$2,780	\$1,095	\$4,690
35	FK-CA3152-4-DD35	\$4,749	No Bolt Kit		FK-CA3152-LK35	\$2,991	\$1,273	\$5,338
40	FK-CA3152-4-DD40	\$5,404	No Bolt Kit		FK-CA3152-LK40	\$3,147	\$1,452	\$6,094
45	FK-CA3152-4-DD45	\$6,039	No Bolt Kit		FK-CA3152-LK45	\$3,313	\$1,631	\$6,849
CASE 3162 Dual Flex (Kit incl. FB-40M, FB-43-CD-LH, FB-44-CD-RH, FB-46-CD-KOC02, FB-4-M-KHC, FB-46-4)								
						FE-30W/30W-3	FE 95W	
30	FK-CA3162-4-FD30	\$4,115	No Bolt Kit		No Lift Kit	\$1,095	\$4,690	
35	FK-CA3162-4-FD35	\$4,749	No Bolt Kit		No Lift Kit	\$1,273	\$5,338	
40	FK-CA3162-4-FD40	\$5,404	No Bolt Kit		No Lift Kit	\$1,452	\$6,094	
45	FK-CA3162-4-FD45	\$6,039	No Bolt Kit		No Lift Kit	\$1,631	\$6,849	

CAN'T
SEE YOUR
FRONT?
GIVE US
A CALL



10 SERIES FRONTS ALSO SUPPORTED



HEAVY CROPS (2 FINGER GUARDS)

Size	Kit	Kit Price	Bolt kit (guard only)	Bolt Kit Price	Lift Kit (with bolts)	Lift Kit Price	Cereal Ext	Platform Ext
CASE 1042 Draper (Kit incl. FD-40 plus FD-4M-13, FD-4M-KHL, FD-4M-KHR)								
25	FK-CA1042-2-DS25	\$2,722	FK-CA1042-BK25	\$340	No Lift Kit		\$576	On request
30	FK-CA1042-2-DS30	\$3,268	FK-CA1042-BK30	\$408	No Lift Kit		\$686	On request
36	FK-CA1042-2-DS36	\$3,923	FK-CA1042-BK36	\$490	No Lift Kit		\$820	On request
CASE 1052 Draper (Kit incl. FD-40 plus FD-4M-13, FD-4M-KHL, FD-4M-KHR)								
25	FK-CA1052-2-DS25	\$2,722	FK-CA1052-BK25	\$340	No Lift Kit		\$576	On request
30	FK-CA1052-2-DS30	\$3,268	FK-CA1052-BK30	\$408	No Lift Kit		\$686	On request
36	FK-CA1052-2-DS36	\$3,923	FK-CA1052-BK36	\$490	No Lift Kit		\$820	On request
CASE 2052 (Kit incl. FD-40 plus FD-4M-13, FD-4M-KHL, FD-4M-KHR)								
30	FK-CA2052-2-DS30	\$3,268	FK-CA2052-BK30	\$408	No Lift Kit		\$686	On request
36	FK-CA2052-2-DS36	\$3,923	FK-CA2052-BK36	\$490	No Lift Kit		\$820	On request
39	FK-CA2052-2-DS39	\$4,251	FK-CA2052-BK39	\$530	No Lift Kit		\$886	On request
CASE 2142 Single Knife (Kit incl. FD-40 plus FD-4M-13, FD-4M-KHL, FD-4M-KHR)								
30	FK-CA2142-2-DS30	\$3,260	FK-CA2142-BK30	\$408	No Lift Kit		\$686	On request
35	FK-CA2142-2-DS35	\$3,806	FK-CA2142-BK35	\$476	No Lift Kit		\$797	On request
40	FK-CA2142-2-DS40	\$4,352	FK-CA2142-BK40	\$544	No Lift Kit		\$908	On request
CASE 2142 Dual Knife (Kit incl. FD-40 plus FD-4M-13, FD-4M-KHL, FD-4M-KHR, FD-40-KOC)								
40	FK-CA2142-2-DD40	\$4,501	FK-CA2142-BK40	\$544	No Lift Kit		\$908	On request
45	FK-CA2142-2-DD45	\$5,047	FK-CA2142-BK45	\$612	No Lift Kit		\$1,019	On request
CASE 2152 Single Knife (Kit incl. FD-40 plus FD-4M-13, FD-4M-KHL, FD-4M-KHR)								
30	FK-CA2152-2-DS30	\$3,260	FK-CA2152-BK30	\$408	No Lift Kit		\$686	On request
35	FK-CA2152-2-DS35	\$3,806	FK-CA2152-BK35	\$476	No Lift Kit		\$797	On request
40	FK-CA2152-2-DS40	\$4,352	FK-CA2152-BK40	\$544	No Lift Kit		\$908	On request
CASE 2152 Dual Knife (Kit incl. FD-40 plus FD-4M-13, FD-4M-KHL, FD-4M-KHR, FD-40-KOC)								
40	FK-CA2152-2-DD40	\$4,501	FK-CA2152-BK40	\$544	No Lift Kit		\$908	On request
45	FK-CA2152-2-DD45	\$5,047	FK-CA2152-BK45	\$612	No Lift Kit		\$1,019	On request
CASE 2162 Single Flex (Kit incl. FD-40 plus FD-4M-13, FD-4M-KHL, FD-4M-KHR)								
30	FK-CA2162-2-FS30	\$3,260	FK-CA2162-BK30	\$408	No Lift Kit		\$686	On request
35	FK-CA2162-2-FS35	\$3,806	FK-CA2162-BK35	\$476	No Lift Kit		\$797	On request
40	FK-CA2162-2-FS40	\$4,352	FK-CA2162-BK40	\$544	No Lift Kit		\$908	On request
CASE 2162 Dual Flex (Kit incl. FD-40 plus FD-4M-13, FD-4M-KHL, FD-4M-KHR, FD-40-KOC)								
40	FK-CA2162-2-FD40	\$4,501	FK-CA2162-BK40	\$544	No Lift Kit		\$908	On request
45	FK-CA2162-2-FD45	\$5,047	FK-CA2162-BK45	\$612	No Lift Kit		\$1,019	On request
CASE 3050 Varifeed Single (Kit incl. FD-40 plus FD-4M-1, FD-4M-13, FD-4M-KHR, FS-2x25)								
30	FK-CA3050-2-RS30	\$3,494	No Bolt Kit		No Lift Kit		\$686	On request
35	FK-CA3050-2-RS35	\$4,066	No Bolt Kit		No Lift Kit		\$797	On request
CASE 3050 Varifeed Dual (Kit incl. FD-40 plus FD-4M-1, FD-4M-13, FD-4M-KHR, FD-40-KOC, FS-2x25)								
41	FK-CA3050-2-RD41	\$5,063	No Bolt Kit		No Lift Kit		\$926	On request

3 FINGER ALLROUNDER KITS AVAILABLE FOR SERIES 21, 3000, 3100, 4100 CONTACT US FOR AVAILABILITY & PRICE





LIGHT CROPS (4 FINGER GUARDS)

Size	Kit	Kit Price	Bolt kit (guard only)	Bolt Kit Price	Lift Kit (with bolts)	Lift Kit Price	Cereal Ext	Platform Ext
------	-----	-----------	-----------------------	----------------	-----------------------	----------------	------------	--------------

MACDON 973 Draper Front (Kit incl. FB-40M plus drive end guards FB-4-M, FB-4-KH, FB-4-3M-KHL)

							FE 13/17/21	FE 50-W-A
30	FK-MA973-4-DS30	\$3,642	FK-MA973-BK30	\$408	FK-MA973-LK30	\$1,317	\$1,095	\$4,582
36	FK-MA973-4-DS36	\$4,377	FK-MA973-BK36	\$490	FK-MA973-LK36	\$1,516	\$1,310	\$5,490
39	FK-MA973-4-DS39	\$4,745	FK-MA973-BK39	\$530	FK-MA973-LK39	\$1,593	\$1,416	\$5,943

Works with the MacDon Wear Plate/Skid Shoe for the following fronts (may require additional part - please ask)

MACDON D60 Draper Single (Kit incl. FB-40M plus drive end guards FB-4-M, FB-4-M-KH, FB-4-3M-KHL)

							FE 13/17/21	FE 50-W-A
30	FK-MAD60-4-DS30	\$3,781	FK-MAD60-BK30	\$408	FK-MAD60-LK30	\$1,319	\$1,095	\$4,582
35	FK-MAD60-4-DS35	\$4,416	FK-MAD60-BK35	\$476	FK-MAD60-LK35	\$1,480	\$1,273	\$5,338
40	FK-MAD60-4-DS40	\$5,051	FK-MAD60-BK40	\$544	FK-MAD60-LK40	\$2,062	\$1,452	\$6,094

MACDON D60 Draper Dual (Kit incl. FB-40M plus drive end guards FB-4-M, FB-4-M-KH, FB-40M-KOC, FB-4-3M-KHL)

40	FK-MAD60-4-DD40	\$5,103	FK-MAD60-BK40	\$544	FK-MAD60-LK40	\$2,062	\$1,452	\$6,094
45	FK-MAD60-4-DD45	\$5,738	FK-MAD60-BK45	\$612	FK-MAD60-LK45	\$2,190	\$1,631	\$6,849

MACDON D65 Draper Single (Kit incl. FB-40M plus drive end guards FB-4-M, FB-4-M-KH, FB-4-3M-KHL)

30	FK-MAD65-4-DS30	\$3,781	FK-MAD65-BK30	\$408	FK-MAD65-LK30	\$1,319	\$1,095	\$4,582
35	FK-MAD65-4-DS35	\$4,416	FK-MAD65-BK35	\$476	FK-MAD65-LK35	\$1,480	\$1,273	\$5,338
40	FK-MAD65-4-DS40	\$5,051	FK-MAD65-BK40	\$544	FK-MAD65-LK40	\$2,062	\$1,452	\$6,094

MACDON D65 Draper Dual (Kit incl. FB-40M plus drive end guards FB-4-M, FB-4-M-KH, FB-40M-KOC, FB-4-3M-KHL)

40	FK-MAD65-4-DD40	\$5,103	FK-MAD65-BK40	\$544	FK-MAD65-LK40	\$2,062	\$1,452	\$6,094
45	FK-MAD65-4-DD45	\$5,738	FK-MAD65-BK45	\$612	FK-MAD65-LK45	\$2,190	\$1,631	\$6,849

MACDON D1 Draper Single (Kit incl. FB-40M plus drive end guards FB-4-M, FB-4-M-KH, FB-4-3M-KHL)

30	FK-MAD1-4-DS30	\$3,781	FK-MAD1-BK30	\$408	FK-MAD1-LK30	\$1,319	\$1,095	\$4,582
35	FK-MAD1-4-DS35	\$4,416	FK-MAD1-BK35	\$476	FK-MAD1-LK35	\$1,480	\$1,273	\$5,338
40	FK-MAD1-4-DS40	\$5,051	FK-MAD1-BK40	\$544	FK-MAD1-LK40	\$2,062	\$1,452	\$6,094

MACDON D1 Draper Dual (Kit incl. FB-40M plus drive end guards FB-4-M, FB-4-M-KH, FB-40M-KOC, FB-4-3M-KHL)

40	FK-MAD1-4-DD40	\$5,103	FK-MAD1-BK40	\$544	FK-MAD1-LK40	\$2,062	\$1,452	\$6,094
45	FK-MAD1-4-DD45	\$5,738	FK-MAD1-BK45	\$612	FK-MAD1-LK45	\$2,190	\$1,631	\$6,849

MACDON FD70 Draper Single (Kit incl. FB-40M plus drive end guards FB-4-M, FB-4-M-KH, FB-4-3M-KHL)

30	FK-MAFD70-4-FS30	\$3,781	FK-MAFD70-BK30	\$408	No Lift Kit		\$1,095	\$4,582
35	FK-MAFD70-4-FS35	\$4,416	FK-MAFD70-BK35	\$476	No Lift Kit		\$1,273	\$5,338
40	FK-MAFD70-4-FS40	\$5,051	FK-MAFD70-BK40	\$544	No Lift Kit		\$1,452	\$6,094

MACDON FD70 Draper Dual (Kit incl. FB-40M plus drive end guards FB-4-M, FB-4-M-KH, FB-40M-KOC, FB-4-3M-KHL)

40	FK-MAFD70-4-FD40	\$5,103	FK-MAFD70-BK40	\$544	No Lift Kit		\$1,452	\$6,094
45	FK-MAFD70-4-FD45	\$5,738	FK-MAFD70-BK45	\$612	No Lift Kit		\$1,631	\$6,849

MACDON FD75 Draper Single (Kit incl. FB-40M plus drive end guards FB-4-M, FB-4-M-KH, FB-4-3M-KHL)

30	FK-MAFD75-4-FS30	\$3,781	FK-MAFD75-BK30	\$408	No Lift Kit		\$1,095	\$4,582
35	FK-MAFD75-4-FS35	\$4,416	FK-MAFD75-BK35	\$476	No Lift Kit		\$1,273	\$5,338
40	FK-MAFD75-4-FS40	\$5,051	FK-MAFD75-BK40	\$544	No Lift Kit		\$1,452	\$6,094

MACDON FD75 Draper Dual (Kit incl. FB-40M plus drive end guards FB-4-M, FB-4-M-KH, FB-40M-KOC, FB-4-3M-KHL)

40	FK-MAFD75-4-FD40	\$5,103	FK-MAFD75-BK40	\$544	No Lift Kit		\$1,452	\$6,094
45	FK-MAFD75-4-FD45	\$5,738	FK-MAFD75-BK45	\$612	No Lift Kit		\$1,631	\$6,849

MACDON F1 Draper Single (Kit incl. FB-40M plus drive end guards FB-4-M, FB-4-M-KH, FB-4-3M-KHL)

30	FK-MAF1-4-FS30	\$3,781	FK-MAF1-BK30	\$408	No Lift Kit		\$1,095	\$4,582
35	FK-MAF1-4-FS35	\$4,416	FK-MAF1-BK35	\$476	No Lift Kit		\$1,273	\$5,338
40	FK-MAF1-4-FS40	\$5,051	FK-MAF1-BK40	\$544	No Lift Kit		\$1,452	\$6,094

MACDON F1 Draper Dual (Kit incl. FB-40M plus drive end guards FB-4-M, FB-4-M-KH, FB-40M-KOC, FB-4-3M-KHL)

40	FK-MAF1-4-FD40	\$5,103	FK-MAF1-BK40	\$544	No Lift Kit		\$1,452	\$6,094
45	FK-MAF1-4-FD45	\$5,738	FK-MAF1-BK45	\$612	No Lift Kit		\$1,631	\$6,849



HEAVY CROPS (2 FINGER GUARDS)

Size	Kit	Kit Price	Bolt kit (guard only)	Bolt Kit Price	Lift Kit (with bolts)	Lift Kit Price	Cereal Ext	Platform Ext
MACDON 973 Draper Front (Kit incl. FD-40 plus FD-4M-13, FD-4M-KHL, FD-4M-KHR)							FE-30W/30W-3	FE 95W
30	FK-MA973-2-DS30	\$3,268	FK-MA973-BK30	\$408	No Lift Kit		\$686	On request
36	FK-MA973-2-DS36	\$3,923	FK-MA973-BK36	\$490	No Lift Kit		\$820	On request
39	FK-MA973-2-DS39	\$4,251	FK-MA973-BK39	\$530	No Lift Kit		\$886	On request

Works with the MacDon Wear Plate/Skid Shoe for the following fronts (may require additional part - please ask)

MACDON D60 Draper Single (Kit incl. FD-40 plus FD-4M-13, FD-4M-KHL, FD-4M-KHR)								
30	FK-MAD60-2-DS30	\$3,260	FK-MAD60-BK30	\$408	No Lift Kit		\$686	On request
35	FK-MAD60-2-DS35	\$3,806	FK-MAD60-BK35	\$476	No Lift Kit		\$797	On request
40	FK-MAD60-2-DS40	\$4,352	FK-MAD60-BK40	\$544	No Lift Kit		\$908	On request

MACDON D60 Draper Dual (Kit incl. FD-40 plus FD-4M-13, FD-4M-KHL, FD-4M-KHR, FD-40-KOC)								
40	FK-MAD60-2-DD40	\$4,501	FK-MAD60-BK40	\$544	No Lift Kit		\$908	On request
45	FK-MAD60-2-DD45	\$5,047	FK-MAD60-BK45	\$612	No Lift Kit		\$1,019	On request

MACDON D65 Draper Single (Kit incl. FD-40 plus FD-4M-13, FD-4M-KHL, FD-4M-KHR)								
30	FK-MAD65-2-DS30	\$3,260	FK-MAD65-BK30	\$408	No Lift Kit		\$686	On request
35	FK-MAD65-2-DS35	\$3,806	FK-MAD65-BK35	\$476	No Lift Kit		\$797	On request
40	FK-MAD65-2-DS40	\$4,352	FK-MAD65-BK40	\$544	No Lift Kit		\$908	On request

MACDON D65 Draper Dual (Kit incl. FD-40 plus FD-4M-13, FD-4M-KHL, FD-4M-KHR, FD-40-KOC)								
40	FK-MAD65-2-DD40	\$4,501	FK-MAD65-BK40	\$544	No Lift Kit		\$908	On request
45	FK-MAD65-2-DD45	\$5,047	FK-MAD65-BK45	\$612	No Lift Kit		\$1,019	On request

MACDON D1 Draper Single (Kit incl. FD-40 plus FD-4M-13, FD-4M-KHL, FD-4M-KHR)								
30	FK-MAD1-2-DS30	\$3,260	FK-MAD1-BK30	\$408	No Lift Kit		\$686	On request
35	FK-MAD1-2-DS35	\$3,806	FK-MAD1-BK35	\$476	No Lift Kit		\$797	On request
40	FK-MAD1-2-DS40	\$4,352	FK-MAD1-BK40	\$544	No Lift Kit		\$908	On request

MACDON D1 Draper Dual (Kit incl. FD-40 plus FD-4M-13, FD-4M-KHL, FD-4M-KHR, FD-40-KOC)								
40	FK-MAD1-2-DD40	\$4,501	FK-MAD1-BK40	\$544	No Lift Kit		\$908	On request
45	FK-MAD1-2-DD45	\$5,047	FK-MAD1-BK45	\$612	No Lift Kit		\$1,019	On request

MACDON FD70 Draper Single (Kit incl. FD-40 plus FD-4M-13, FD-4M-KHL, FD-4M-KHR)								
30	FK-MAFD70-2-FS30	\$3,260	FK-MAFD70-BK30	\$408	No Lift Kit		\$686	On request
35	FK-MAFD70-2-FS35	\$3,806	FK-MAFD70-BK35	\$476	No Lift Kit		\$797	On request
40	FK-MAFD70-2-FS40	\$4,352	FK-MAFD70-BK40	\$544	No Lift Kit		\$908	On request

MACDON FD70 Draper Dual (Kit incl. FD-40 plus FD-4M-13, FD-4M-KHL, FD-4M-KHR, FD-40-KOC)								
40	FK-MAFD70-2-FD40	\$4,501	FK-MAFD70-BK40	\$544	No Lift Kit		\$908	On request
45	FK-MAFD70-2-FD45	\$5,047	FK-MAFD70-BK45	\$612	No Lift Kit		\$1,019	On request

MACDON FD75 Draper Single (Kit incl. FD-40 plus FD-4M-13, FD-4M-KHL, FD-4M-KHR)								
30	FK-MAFD75-2-FS30	\$3,260	FK-MAFD75-BK30	\$408	No Lift Kit		\$686	On request
35	FK-MAFD75-2-FS35	\$3,806	FK-MAFD75-BK35	\$476	No Lift Kit		\$797	On request
40	FK-MAFD75-2-FS40	\$4,352	FK-MAFD75-BK40	\$544	No Lift Kit		\$908	On request

MACDON FD75 Draper Dual (Kit incl. FD-40 plus FD-4M-13, FD-4M-KHL, FD-4M-KHR, FD-40-KOC)								
40	FK-MAFD75-2-FD40	\$4,501	FK-MAFD75-BK40	\$544	No Lift Kit		\$908	On request
45	FK-MAFD75-2-FD45	\$5,047	FK-MAFD75-BK45	\$612	No Lift Kit		\$1,019	On request

MACDON F1 Draper Single (Kit incl. FD-40 plus FD-4M-13, FD-4M-KHL, FD-4M-KHR)								
30	FK-MAF1-2-FS30	\$3,260	FK-MAF1-BK30	\$408	No Lift Kit		\$686	On request
35	FK-MAF1-2-FS35	\$3,806	FK-MAF1-BK35	\$476	No Lift Kit		\$797	On request
40	FK-MAF1-2-FS40	\$4,352	FK-MAF1-BK40	\$544	No Lift Kit		\$908	On request

MACDON F1 Draper Dual (Kit incl. FD-40 plus FD-4M-13, FD-4M-KHL, FD-4M-KHR, FD-40-KOC)								
40	FK-MAF1-2-FD40	\$4,501	FK-MAF1-BK40	\$544	No Lift Kit		\$908	On request
45	FK-MAF1-2-FD45	\$5,047	FK-MAF1-BK45	\$612	No Lift Kit		\$1,019	On request





LIGHT CROPS (4 FINGER GUARDS)

Size	Kit	Kit Price	Bolt kit (guard only)	Bolt Kit Price	Lift Kit (with bolts)	Lift Kit Price	Cereal Ext	Platform Ext
NH 83C Draper Single Knife (Kit incl. FB-40M plus drive end guards FB-4-M, FB-4-M-KH, FB-4-3M-KHL)							FE 13/17/21	FE 50-W-A
30	FK-NH83C-4-DS30	\$3,781	No Bolt Kit		FK-NH83C-LK30	\$1,319	\$1,095	\$4,582
35	FK-NH83C-4-DS35	\$4,416	No Bolt Kit		FK-NH83C-LK35	\$1,480	\$1,273	\$5,338
40	FK-NH83C-4-DS40	\$5,051	No Bolt Kit		FK-NH83C-LK40	\$2,062	\$1,452	\$6,094
NH 83C Draper Dual Knife (Kit incl. FB-40M plus FB-4-M, FB-4-M-KH, FB-4-3M-KHL, FB-40M-KOC)							FE 13/17/21	FE 50-W-A
40	FK-NH83C-4-DD40	\$5,103	No Bolt Kit		FK-NH83C-LK40	\$2,062	\$1,452	\$6,094
45	FK-NH83C-4-DD45	\$5,738	No Bolt Kit		FK-NH83C-LK45	\$2,190	\$1,631	\$6,849
NH 86C Flex Single Knife (Kit incl. FB-40M plus drive end guards FB-4-M, FB-4-M-KH, FB-4-3M-KHL)							FE 13/17/21	FE 50-W-A
30	FK-NH86C-4-FS30	\$3,781	No Bolt Kit		No Lift Kit		\$1,095	\$4,582
35	FK-NH86C-4-FS35	\$4,416	No Bolt Kit		No Lift Kit		\$1,273	\$5,338
40	FK-NH86C-4-FS40	\$5,051	No Bolt Kit		No Lift Kit		\$1,452	\$6,094
NH 83C Flex Dual Knife (Kit incl. FB-40M plus FB-4-M, FB-4-M-KH, FB-4-3M-KHL, FB-40M-KOC)							FE 13/17/21	FE 50-W-A
40	FK-NH86C-4-FD40	\$5,103	No Bolt Kit		No Lift Kit		\$1,452	\$6,094
45	FK-NH86C-4-FD45	\$5,738	No Bolt Kit		No Lift Kit		\$1,631	\$6,849
NH 760CG Varifeed Single (Kit incl. FB-40M plus drive end guards FB-42-M4, FB-49-5, FS-2 x 25)								
30	FK-NH760CG-4-RS30	\$3,948	No Bolt Kit		No Lift Kit		\$1,095	\$4,582
35	FK-NH760CG-4-RS35	\$4,587	No Bolt Kit		No Lift Kit		\$1,273	\$5,338
NH 760CG Varifeed Dual (Kit incl. FB-40M plus special guards FB-40M-KOC, FB-42-M4, FB-49-5, V-HDCLIP, FS-2 X25)								
41	FK-NH760CG-4-RD41	\$5,516	No Bolt Kit		No Lift Kit		\$1,488	\$6,245
NH 94C Draper Single Knife (Kit incl. FB-40M plus drive end guard FB-43-3M)							FE 13/17/21	FE 50-W-A
30	FK-NH94C-4-DS30	\$3,745	No Bolt Kit		No Lift Kit		\$1,095	\$4,582
36	FK-NH94C-4-DS36	\$4,480	No Bolt Kit		No Lift Kit		\$1,310	\$5,490
NH 94C Draper Dual Knife (Kit incl. FB-40M plus FB-43-3M, FB-40M-KOC)							FE 13/17/21	FE 50-W-A
40	FK-NH94C-4-DD40	\$5,121	No Bolt Kit		No Lift Kit		\$1,452	\$6,094
42	FK-NH94C-4-DD42	\$5,366	No Bolt Kit		No Lift Kit		\$1,523	\$6,396
NH 71C Rigid Dual Knife (Kit incl. FB-40M plus FB-43-3M, FB-46-4, FB-47-5-KOC, FB-48-4, FB-49-5)							FE 13/17/21	FE 50-W-A
24	FK-NH71C-4-RD24	\$3,184	No Bolt Kit		No Lift Kit		\$880	\$4,325
30	FK-NH71C-4-RD30	\$3,919	No Bolt Kit		No Lift Kit		\$1,095	\$4,582
NH 72C Rigid Dual Knife (Kit incl. FB-40M plus FB-43-3M, FB-46-4, FB-47-5-KOC, FB-48-4, FB-49-5)							FE 13/17/21	FE 50-W-A
24	FK-NH72C-4-RD24	\$3,184	No Bolt Kit		No Lift Kit		\$880	\$4,325
30	FK-NH72C-4-RD30	\$3,919	No Bolt Kit		No Lift Kit		\$1,095	\$4,582
NH 971 Rigid Dual Knife (Kit incl. FB-40M plus FB-43-3M, FB-46-4, FB-47-5-KOC, FB-48-4, FB-49-5)							FE 13/17/21	FE 50-W-A
24	FK-NH971-4-RD24	\$3,184	No Bolt Kit		No Lift Kit		\$880	\$4,325
30	FK-NH971-4-RD30	\$3,919	No Bolt Kit		No Lift Kit		\$1,095	\$4,582
NH 840CD Dual Knife (Kit incl. FB-40M, FB-43-CD-LH, FB-44-CD-RH, FB-46-CD-KOC02, FB-4-M-KHC, FB-46-4)							FE 13/17/21	FE 50-W-A
30	FK-NH840CD-4-DD30	\$4,115	No Bolt Kit		FK-NH840CD-LK30	\$2,780	\$1,095	\$4,582
35	FK-NH840CD-4-DD35	\$4,749	No Bolt Kit		FK-NH840CD-LK35	\$2,991	\$1,273	\$5,338
40	FK-NH840CD-4-DD40	\$5,404	No Bolt Kit		FK-NH840CD-LK40	\$3,147	\$1,452	\$6,094
45	FK-NH840CD-4-DD45	\$6,039	No Bolt Kit		FK-NH840CD-LK45	\$3,313	\$1,631	\$6,849
NH 880 Superflex Dual (Kit incl. FB-40M, FB-43-CD-LH, FB-44-CD-RH, FB-46-CD-KOC02, FB-4-M-KHC, FB-46-4)								
30	FK-NH880-4-FD30	\$4,115	No Bolt Kit		No Lift Kit		\$1,095	\$4,582
35	FK-NH880-4-FD35	\$4,749	No Bolt Kit		No Lift Kit		\$1,273	\$5,338
40	FK-NH880-4-FD40	\$5,404	No Bolt Kit		No Lift Kit		\$1,452	\$6,094
45	FK-NH880-4-FD45	\$6,039	No Bolt Kit		No Lift Kit		\$1,631	\$6,849



HEAVY CROPS (2 FINGER GUARDS)

Size	Kit	Kit Price	Bolt kit (guard only)	Bolt Kit Price	Lift Kit (with bolts)	Lift Kit Price	Cereal Ext	Platform Ext
NH 83C Draper Single Knife (Kit incl. FD-40 plus FD-4M-13, FD-4M-KHL, FD-4M-KHR)								
							FE-30W/30W-3	FE 95W
30	FK-NH83C-2-DS30	\$3,260	No Bolt Kit		No Lift Kit		\$686	On request
35	FK-NH83C-2-DS35	\$3,806	No Bolt Kit		No Lift Kit		\$797	On request
40	FK-NH83C-2-DS40	\$4,352	No Bolt Kit		No Lift Kit		\$908	On request
NH 83C Draper Dual Knife (Kit incl. FD-40 plus FD-4M-13, FD-4M-KHL, FD-4M-KHR, FD-40-KOC)								
							FE-30W/30W-3	FE 95W
40	FK-NH83C-2-DD40	\$4,501	No Bolt Kit		No Lift Kit		\$908	On request
45	FK-NH83C-2-DD45	\$5,047	No Bolt Kit		No Lift Kit		\$1,019	On request
NH 86C Flex Single Knife (Kit incl. FD-40 plus FD-4M-13, FD-4M-KHL, FD-4M-KHR)								
							FE-30W/30W-3	FE 95W
30	FK-NH86C-2-FS30	\$3,260	No Bolt Kit		No Lift Kit		\$686	On request
35	FK-NH86C-2-FS35	\$3,806	No Bolt Kit		No Lift Kit		\$797	On request
40	FK-NH86C-2-FS40	\$4,352	No Bolt Kit		No Lift Kit		\$908	On request
NH 83C Flex Dual Knife (Kit incl. FD-40 plus FD-4M-13, FD-4M-KHL, FD-4M-KHR, FD-40-KOC)								
							FE-30W/30W-3	FE 95W
40	FK-NH86C-2-FD40	\$4,501	No Bolt Kit		No Lift Kit		\$908	On request
45	FK-NH86C-2-FD45	\$5,047	No Bolt Kit		No Lift Kit		\$1,019	On request
NH 760CG Varifeed Single (Kit incl. FD-40 plus FD-4M-1, FD-4M-13, FD-4M-KHR, FS-2x25)								
30	FK-NH760CG-2-RS30	\$3,494	No Bolt Kit		No Lift Kit		\$686	On request
35	FK-NH760CG-2-RS35	\$4,066	No Bolt Kit		No Lift Kit		\$797	On request
NH 760CG Varifeed Dual (Kit incl. FD-40 plus FD-4M-1, FD-4M-13, FD-4M-KHR, FD-40-KOC, FS-2x25)								
41	FK-NH760CG-2-RD41	\$5,063	No Bolt Kit		No Lift Kit		\$926	On request



3 FINGER ALLROUNDER KITS AVAILABLE FOR 840CD, 760CG, 83C & 86C

CONTACT US FOR AVAILABILITY & PRICE

HOLLAND





GLEANER



LIGHT CROPS (4 FINGER GUARDS)

Size	Kit	Kit Price	Bolt kit (guard only)	Bolt Kit Price	Lift Kit (with bolts)	Lift Kit Price	Cereal Ext	Platform Ext
AGCO 600 SERIES Draper Front (Kit incl. FB-36-AGCO plus drive end guard FB-36-3-AGCO)								
If the existing Guards have NO built in wear strip								
							FE 13/17/21	FE 50-W-A
25	FK-AG600-4-DS25	\$4,150	No Bolt Kit		No Lift Kit		\$916	\$3,826
30	FK-AG600-4-DS30	\$4,964	No Bolt Kit		No Lift Kit		\$1,097	\$4,582
36	FK-AG600-4-DS36	\$5,941	No Bolt Kit		No Lift Kit		\$1,310	\$5,516

AGCO 600 SERIES Draper Front (Kit incl. FB-3-AGCO plus drive end guard FB-3-3-AGCO)								
If the existing Guards HAVE built in wear strip								
							FE 13/17/21	FE 50-W-A
25	FK-AG600WS-4-DS25	\$4,757	No Bolt Kit		No Lift Kit		\$916	\$3,826
30	FK-AG600WS-4-DS30	\$5,690	No Bolt Kit		No Lift Kit		\$1,095	\$4,582
36	FK-AG600WS-4-DS36	\$6,809	No Bolt Kit		No Lift Kit		\$1,310	\$5,516

GLEANER / AGCO 400 SERIES Rigid Front (Kit incl. FB-1-HB plus drive end guard FB-1-3-HB)								
							FE 13/17/21	FE 50-W-A
21	FK-AG400-4-RS21	\$3,029	No Bolt Kit		No Lift Kit		\$774	\$3,223
25	FK-AG400-4-RS25	\$3,586	No Bolt Kit		No Lift Kit		\$916	\$3,825
30	FK-AG400-4-RS30	\$4,282	No Bolt Kit		No Lift Kit		\$1,095	\$4,582

GLEANER / AGCO 700 SERIES Rigid Front (Kit incl. FB-1-HB plus drive end guard FB-1-3-HB)								
							FE 13/17/21	FE 50-W-A
21	FK-AG700-4-RS21	\$3,029	No Bolt Kit		No Lift Kit		\$774	\$3,223
25	FK-AG700-4-RS25	\$3,586	No Bolt Kit		No Lift Kit		\$916	\$3,825
30	FK-AG700-4-RS30	\$4,282	No Bolt Kit		No Lift Kit		\$1,095	\$4,582

GLEANER 5000 Draper Front (Kit incl. FB-3-AGCO plus drive end guard FB-3-3-AGCO)								
							FE 13/17/21	FE 50-W-A
22	FK-AG5000-4-DS22	\$4,197	No Bolt Kit		No Lift Kit		\$809	\$3,373
25	FK-AG5000-4-DS25	\$4,757	No Bolt Kit		No Lift Kit		\$916	\$3,827
30	FK-AG5000-4-DS30	\$5,690	No Bolt Kit		No Lift Kit		\$1,095	\$4,582
36	FK-AG5000-4-DS36	\$6,809	No Bolt Kit		No Lift Kit		\$1,310	\$5,490

AGCO / GLEANER/ MF 9250 DYNAFLEX Draper (Dual Knife)								
(Kit incl. FB-3-3-AGCO plus FB-3-3-AGCO-DE, FB-3-4-AGCO-DE, FB-3-AGCO-DE, FB-3-AGCO-KOC)								
Originally fitted with Schumacher guards and roller-type hold downs								
Comprehensive bolt kit required consisting of replacement knife heads , shims, hold down clips								
							FE 13/17/21	FE 50-W-A
30	FK-AG9250-4-FD30	\$5,688	FK-AG9250-BK30	\$1,157	No Lift Kit		\$1,095	\$4,582
35	FK-AG9250-4-FD35	\$6,621	FK-AG9250-BK35	\$1,204	No Lift Kit		\$1,382	\$5,338
40	FK-AG9250-4-FD40	\$7,554	FK-AG9250-BK40	\$1,266	No Lift Kit		\$1,452	\$6,094
30	FK-JD930F-4-FS30	\$5,154	No Bolt Kit		No Lift Kit		\$1,095	\$4,584

IDEAL (POWER FLOW)								
25	FK-IDEAL-4-DD25	On request	On request		On request		On request	On request
30	FK-IDEAL-4-DD30	On request	On request		On request		On request	On request
35	FK-IDEAL-4-DD35	On request	On request		On request		On request	On request
40	FK-IDEAL-4-DD30	On request	On request		On request		On request	On request

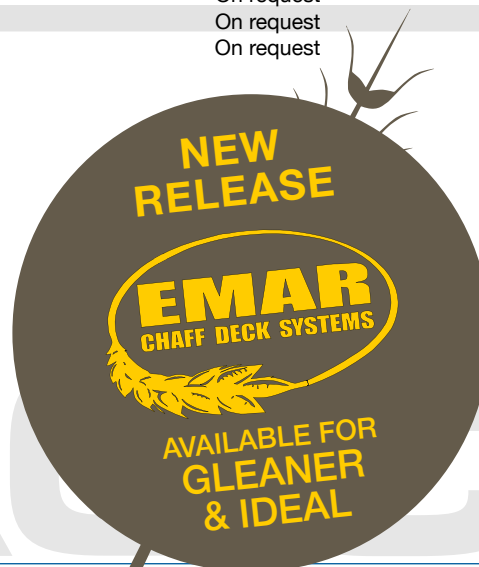

AGCO

GLEANER

MASSEY FERGUSON

MASSEY FERGUSON

GLEANER

AGCO Your Agriculture Company



LIGHT CROPS (4 FINGER GUARDS)

Size	Kit	Kit Price	Bolt kit (guard only)	Bolt Kit Price	Lift Kit (with bolts)	Lift Kit Price	Cereal Ext	Platform Ext
CLAAS CS / CATERPILLAR LEXION Rigid Single Knife (Kit incl. FB-40M plus drive end guards FB-41-M3, FB-42-M4, FB-40M-CEG)								
							FE 13/17/21	FE 50-W-A
22.5	FK-CLCS-4-RS22.5	\$2,800	No Bolt Kit		No Lift Kit		\$827	\$3,449
25	FK-CLCS-4-RS25	\$3,107	No Bolt Kit		No Lift Kit		\$916	\$3,827
30	FK-CLCS-4-RS30	\$3,720	No Bolt Kit		No Lift Kit		\$1,095	\$4,582

CLAAS VARIO Rigid Dual Knife (Kit incl. FB-40M, FB-40M-KOC, FB-47-CL-DE-2, FB-49-5)

Size	Kit	Kit Price	Bolt kit (guard only)	Bolt Kit Price	Lift Kit (with bolts)	Lift Kit Price	Cereal Ext	Platform Ext
							FE 13/17/21	FE 50-W-A
30	FK-CLVARIO-4-RD30	\$3,928	No Bolt Kit		FK-CLVARIO-LK30	\$2,487	\$1,095	\$4,582
35	FK-CLVARIO-4-RD35	\$4,541	No Bolt Kit		FK-CLVARIO-LK35	\$2,683	\$1,273	\$5,338
40	FK-CLVARIO-4-RD40	\$5,154	No Bolt Kit		FK-CLVARIO-LK40	\$2,879	\$1,452	\$6,094
45	FK-CLVARIO-4-RD45	\$5,767	No Bolt Kit		FK-CLVARIO-LK45	\$3,075	\$1,634	\$6,849

CLAAS MAXFLO DRAPER Dual Knife (Kit incl. FB-40M, FB-40M-KOC, FB-47-CL-DE-2, FB-49-5)

Size	Kit	Kit Price	Bolt kit (guard only)	Bolt Kit Price	Lift Kit (with bolts)	Lift Kit Price	Cereal Ext	Platform Ext
							FE 13/17/21	FE 50-W-A
34	FK-CLMAXFL-4-DD34	\$4,418	No Bolt Kit		FK-CLMAXFL-LK34	\$2,668	\$1,237	\$5,187
40	FK-CLMAXFL-4-DD40	\$5,154	No Bolt Kit		FK-CLMAXFL-LK40	\$2,879	\$1,452	\$6,094



HEAVY CROPS (2 FINGER GUARDS)

Size	Kit	Kit Price	Bolt kit (guard only)	Bolt Kit Price	Lift Kit (with bolts)	Lift Kit Price	Cereal Ext	Platform Ext
CLAAS CS / CATERPILLAR LEXION Rigid Single Knife (Kit incl. FD-40 plus FD-4M-13, FD-4M-KHL, FD-4M-KHR)								
							FE-30W/ 30W-3	FE 95W
22.5	FK-CLCS-2-RS22.5	\$2,449	No Bolt Kit		No Lift Kit		\$524	On request
25	FK-CLCS-2-RS25	\$2,722	No Bolt Kit		No Lift Kit		\$575	On request
30	FK-CLCS-2-RS30	\$3,268	No Bolt Kit		No Lift Kit		\$686	On request

CLAAS VARIO Rigid Dual Knife (Kit incl. FD-40 plus FD-4M-13, FD-4M-KHL, FD-4M-KHR, FD-40-KOC)

Size	Kit	Kit Price	Bolt kit (guard only)	Bolt Kit Price	Lift Kit (with bolts)	Lift Kit Price	Cereal Ext	Platform Ext
							FE-30W/ 30W-3	FE 95W
30	FK-CLVARIO-2-RD30	\$3,805	No Bolt Kit		No Lift Kit		\$686	On request
35	FK-CLVARIO-2-RD35	\$4,351	No Bolt Kit		No Lift Kit		\$797	On request
40	FK-CLVARIO-2-RD40	\$4,897	No Bolt Kit		No Lift Kit		\$908	On request
45	FK-CLVARIO-2-RD45	\$5,443	No Bolt Kit		No Lift Kit		\$1,019	On request

CLAAS MAXFLO DRAPER Dual Knife (Kit incl. FD-40 plus FD-4M-13, FD-4M-KHL, FD-4M-KHR, FD-40-KOC)

Size	Kit	Kit Price	Bolt kit (guard only)	Bolt Kit Price	Lift Kit (with bolts)	Lift Kit Price	Cereal Ext	Platform Ext
							FE-30W/ 30W-3	FE 95W
34	FK-CLMAXFL-2-DD34	\$4,242	No Bolt Kit		No Lift Kit		\$767	On request
40	FK-CLMAXFL-2-DD40	\$4,897	No Bolt Kit		No Lift Kit		\$908	On request

3 FINGER ALLROUNDER KITS AVAILABLE FOR CONVIO & CONVIO FLEX FRONTS CONTACT US FOR AVAILABILITY & PRICE





ADAPT-A-GAP™ CROP FINGER SYSTEM



LIGHT CROPS (4 FINGER GUARDS)

Size	Kit	Kit Price	Bolt kit (guard only)	Bolt Kit Price	Lift Kit (with bolts)	Lift Kit Price	Cereal Ext	Platform Ext
HB "SP" Draper Single Knife (Kit incl. FB-1-HB plus FB-1-3-HB-DE, FB-1-HB-DE) (Originally fitted with Schumacher Guards)								
30	FK-HBSP-4-DS30	\$4,319	FK-HBSP-BK30	\$514	No Lift Kit		FE 13/17/21	FE 50-W-A
36	FK-HBSP-4-DS36	\$5,154	FK-HBSP-BK36	\$616	No Lift Kit		\$1,095	\$4,582
							\$1,309	\$5,490
HB "SP" Draper Dual Knife (Kit incl. FB-1-HB, FB-1-3-HB-DE, FB-1-4-HB-DE, FB-1-HB-DE, FB-1-HB-KOC) (Originally fitted with Schumacher Guards)								
40	FK-HBSP-4-DD40	\$5,947	FK-HBSP-BK40	\$687	No Lift Kit		FE 13/17/21	FE 50-W-A
42	FK-HBSP-4-DD42	\$6,226	FK-HBSP-BK42	\$729	No Lift Kit		\$1,403	\$5,888
							\$1,472	\$6,180
HB "Grain Belt Plus" Draper Dual Knife (Kit incl. FB-1-HB, FB-1-3-HB-DE, FB-1-4-HB-DE, FB-1-HB-DE, FB-1-HB-KOC) (Originally fitted with Schumacher Guards)								
30	FK-HBGBP-4-DD30	\$4,555	No Bolt Kit		No Lift Kit		FE 13/17/21	FE 50-W-A
36	FK-HBGBP-4-DD36	\$5,390	No Bolt Kit		No Lift Kit		\$1,095	\$4,583
42	FK-HBGBP-4-DD42	\$6,226	No Bolt Kit		No Lift Kit		\$1,310	\$5,490
45	FK-HBGBP-4-DD45	\$6,643	No Bolt Kit		No Lift Kit		\$1,523	\$6,396
							\$1,631	\$6,849
HB "SP" Draper Single Knife (Kit incl. FB-40-M plus FB-4-3M-KHL, FB-4-M-KH) (Originally fitted with Cray Guards)								
30	FK-HBSP30-4-DS30	\$3,664	No Bolt Kit		No Lift Kit		FE 13/17/21	FE 50-W-A
36	FK-HBSP30S-4-DS36	\$4,400	No Bolt Kit		No Lift Kit		\$1,095	\$4,582
							\$1,309	\$5,490
HB "SP" Draper Dual Knife (Originally fitted with Cray Guards)(Kit incl. FB-40-M plus FB-4-3M-KHL, FB-4-M-KH, FB-40-M-KOC)								
40	FK-HBSP40-4-DD40	\$5,019	No Bolt Kit		No Lift Kit		FE 13/17/21	FE 50-W-A
42	FK-HBSP42-4-DD42	\$5,264	No Bolt Kit		No Lift Kit		\$1,403	\$5,888
							\$1,472	\$6,180
HB "Grain Belt Plus" Draper Dual Knife (Originally fitted with Cray Guards)(Kit incl. FB-40-M plus FB-4-3M-KHL, FB-4-M-KH, FB-40-M-KOC)								
30	FK-HB3055-4-DD30	\$3,793	No Bolt Kit		No Lift Kit		FE 13/17/21	FE 50-W-A
36	FK-HB3655S-4-DD36	\$4,529	No Bolt Kit		No Lift Kit		\$1,095	\$4,583
42	FK-HB4255-4-DD42	\$5,264	No Bolt Kit		No Lift Kit		\$1,310	\$5,490
45	FK-HB4555-4-DD45	\$5,632	No Bolt Kit		No Lift Kit		\$1,523	\$6,396
							\$1,631	\$6,849
HB 4000 Series Draper Dual Knife (Kit incl. FB-40M, FB-4-3M, FB-40M-KOC) (Originally fitted with Schumacher Guards)								
36	FK-HB4000-4-DD36	\$4,587	No Bolt Kit		FK-HB4000-LK36	\$1,694	FE 13/17/21	FE 50-W-A
40	FK-HB4000-4-DD40	\$5,078	No Bolt Kit		FK-HB4000-LK40	\$1,776	\$1,272	\$5,330
45	FK-HB4000-4-DD45	\$5,691	No Bolt Kit		FK-HB4000-LK45	\$1,959	\$1,452	\$6,094
							\$1,631	\$6,849
HB AIRFLEX Draper Dual Knife (Kit incl. FB-40M, FB-40-HBA-DEL, FB-40-HBA-DER, FB-4-CD-KOC) (Originally fitted with Schumacher Guards)								
36	FK-HBAIRF-4-DD36	\$4,825	FK-HBAIRF-BK36	\$974	No Lift Kit		FE 13/17/21	FE 50-W-A
40	FK-HBAIRF-4-DD40	\$5,315	FK-HBAIRF-BK40	\$1,080	No Lift Kit		\$1,310	\$5,490
45	FK-HBAIRF-4-DD45	\$5,928	FK-HBAIRF-BK45	\$1,212	No Lift Kit		\$1,452	\$6,094
50	FK-HBAIRF-4-DD50	\$6,541	FK-HBAIRF-BK50	\$1,344	No Lift Kit		\$1,631	\$6,849
							\$1,810	\$7,605

HEAVY CROPS (2 FINGER GUARDS)

HB 4000 Series Draper Dual Knife (Kit incl. FD-40, FD-4M-KHL, FD-4M-KHR, FD-40-KOC) (Originally fitted with Schumacher Guards)								
36	FK-HB4000-2-DD36	\$4,657	No Bolt Kit	No Lift Kit		\$820	FE-30W/30W-3	FE 95W
40	FK-HB4000-2-DD40	\$5,093	No Bolt Kit	No Lift Kit		\$908	On request	On request
45	FK-HB4000-2-DD45	\$5,639	No Bolt Kit	No Lift Kit		\$1,019	On request	On request
HB AIRFLEX Draper Dual Knife (Kit incl. FD-40, FD-40-HBA-DEL, FD-40-HBA-DER, FD-4-CD-KOC) (Originally fitted with Schumacher Guards)								
36	FK-HBAIRF-2-DD36	\$4,075	FK-HBAIRF-BK36	\$974	No Lift Kit		FE-30W/30W-3	FE 95W
40	FK-HBAIRF-2-DD40	\$4,511	FK-HBAIRF-BK40	\$1,080	No Lift Kit		\$820	On request
45	FK-HBAIRF-2-DD45	\$5,057	FK-HBAIRF-BK45	\$1,212	No Lift Kit		\$907	On request
50	FK-HBAIRF-2-DD50	\$5,603	FK-HBAIRF-BK50	\$1,344	No Lift Kit		\$1,019	On request
							\$1,130	On request





LIGHT CROPS (4 FINGER GUARDS)

Size	Kit	Kit Price	Bolt kit (guard only)	Bolt Kit Price	Lift Kit (with bolts)	Lift Kit Price	Cereal Ext	Platform Ext
MIDWEST CROPHAWK Draper Dual Knife (Kit incl. FB-40M plus FB-4-M, FB-40M-KOC)								
							FE 13/17/21	FE 50-W-A
36	FK-MWCROPH-4-DD36	\$4,443	No Bolt Kit		No Lift Kit		\$1,296	\$5,458
40	FK-MWCROPH-4-DD40	\$4,933	No Bolt Kit		No Lift Kit		\$1,440	\$6,064
42	FK-MWCROPH-4-DD42	\$5,178	No Bolt Kit		No Lift Kit		\$1,512	\$6,367
45	FK-MWCROPH-4-DD45	\$5,546	No Bolt Kit		No Lift Kit		\$1,620	\$6,822
50	FK-MWCROPH-4-DD50	\$6,159	No Bolt Kit		No Lift Kit		\$1,800	\$7,580

MIDWEST DURAS Draper Dual Knife (Kit incl. FB-40M plus FB-4-M, FB-40M-KOC)

Size	Kit	Kit Price	Bolt kit (guard only)	Bolt Kit Price	Lift Kit (with bolts)	Lift Kit Price	Cereal Ext	Platform Ext
MIDWEST DURAS Draper Dual Knife (Kit incl. FB-40M plus FB-4-M, FB-40M-KOC)								
							FE 13/17/21	FE 50-W-A
36	FK-MWDURAS-4-DD36	\$4,406	No Bolt Kit		No Lift Kit		\$1,296	\$5,458
40	FK-MWDURAS-4-DD40	\$4,896	No Bolt Kit		No Lift Kit		\$1,440	\$6,064
42	FK-MWDURAS-4-DD42	\$5,141	No Bolt Kit		No Lift Kit		\$1,512	\$6,367
45	FK-MWDURAS-4-DD45	\$5,509	No Bolt Kit		No Lift Kit		\$1,620	\$6,822
50	FK-MWDURAS-4-DD50	\$6,122	No Bolt Kit		No Lift Kit		\$1,800	\$7,580
60	FK-MWDURAS-4-DD60	On request	No Bolt Kit		No Lift Kit		On request	On request

MEDIUM CROPS (3 FINGER GUARDS)

MIDWEST CROPHAWK Draper Dual Knife (Kit incl. FG-40M plus FG-4M, FG-40M-KOC)

Size	Kit	Kit Price	Bolt kit (guard only)	Bolt Kit Price	Lift Kit (with bolts)	Lift Kit Price	Cereal Ext	Platform Ext	
MIDWEST CROPHAWK Draper Dual Knife (Kit incl. FG-40M plus FG-4M, FG-40M-KOC)									
							FE 13/17/21	FE 30W/30W-3	FE 65W-A
36	FK-MWCROPH-3-DD36	\$4,406	No Bolt Kit		No Lift Kit	\$904	\$1,161	\$4,941	
40	FK-MWCROPH-3-DD40	\$4,896	No Bolt Kit		No Lift Kit	\$1,002	\$1,288	\$5,691	
42	FK-MWCROPH-3-DD42	\$5,141	No Bolt Kit		No Lift Kit	\$1,051	\$1,345	\$5,757	
45	FK-MWCROPH-3-DD45	\$5,509	No Bolt Kit		No Lift Kit	\$1,125	\$1,446	\$6,164	
50	FK-MWCROPH-3-DD50	\$6,122	No Bolt Kit		No Lift Kit	\$1,247	\$1,636	\$6,844	

MIDWEST DURAS Draper Dual Knife (Kit incl. FG-40M plus FG-4M, FG-40M-KOC)

Size	Kit	Kit Price	Bolt kit (guard only)	Bolt Kit Price	Lift Kit (with bolts)	Lift Kit Price	Cereal Ext	Platform Ext	
MIDWEST DURAS Draper Dual Knife (Kit incl. FG-40M plus FG-4M, FG-40M-KOC)									
							FE 13/17/21	FE 30W/30W-3	FE 65W-A
36	FK-MWDURAS-3-DD36	\$4,406	No Bolt Kit		No Lift Kit	\$904	\$1,161	\$4,941	
40	FK-MWDURAS-3-DD40	\$4,896	No Bolt Kit		No Lift Kit	\$1,002	\$1,288	\$5,691	
42	FK-MWDURAS-3-DD42	\$5,141	No Bolt Kit		No Lift Kit	\$1,051	\$1,345	\$5,757	
45	FK-MWDURAS-3-DD45	\$5,509	No Bolt Kit		No Lift Kit	\$1,125	\$1,446	\$6,164	
50	FK-MWDURAS-3-DD50	\$6,122	No Bolt Kit		No Lift Kit	\$1,247	\$1,636	\$6,844	
60	FK-MWDURAS-3-DD60	On request	No Bolt Kit		No Lift Kit	On request	On request	On request	

HEAVY CROPS (2 FINGER GUARDS)

MIDWEST CROPHAWK Draper Dual Knife (Kit incl. FD-40 plus FD-4M-13, FD-4M-KHL, FD-4M-KHR, FD-40-KOC)

Size	Kit	Kit Price	Bolt kit (guard only)	Bolt Kit Price	Lift Kit (with bolts)	Lift Kit Price	Cereal Ext	Platform Ext
MIDWEST CROPHAWK Draper Dual Knife (Kit incl. FD-40 plus FD-4M-13, FD-4M-KHL, FD-4M-KHR, FD-40-KOC)								
							FE 30W/30W-3	FE 95W
36	FK-MWCROPH-2-DD36	\$4,254	No Bolt Kit		No Lift Kit		\$782	\$3,493
40	FK-MWCROPH-2-DD40	\$4,691	No Bolt Kit		No Lift Kit		\$865	\$3,880
42	FK-MWCROPH-2-DD42	\$4,910	No Bolt Kit		No Lift Kit		\$912	\$4,079
45	FK-MWCROPH-2-DD45	\$5,237	No Bolt Kit		No Lift Kit		\$971	\$4,365
50	FK-MWCROPH-2-DD50	\$5,783	No Bolt Kit		No Lift Kit		\$1,077	\$4,851
60	FK-MWCROPH-2-DD60	On request	No Bolt Kit		No Lift Kit		On request	On request

MIDWEST DURAS Draper Dual Knife (Kit incl. FD-40 plus FD-4M-13, FD-4M-KHL, FD-4M-KHR, FD-40-KOC)

Size	Kit	Kit Price	Bolt kit (guard only)	Bolt Kit Price	Lift Kit (with bolts)	Lift Kit Price	Cereal Ext	Platform Ext
MIDWEST DURAS Draper Dual Knife (Kit incl. FD-40 plus FD-4M-13, FD-4M-KHL, FD-4M-KHR, FD-40-KOC)								
							FE 30W/30W-3	FE 95W
36	FK-MWDURAS-2-DD36	\$4,254	No Bolt Kit		No Lift Kit		\$782	\$3,493
40	FK-MWDURAS-2-DD40	\$4,691	No Bolt Kit		No Lift Kit		\$865	\$3,880
42	FK-MWDURAS-2-DD42	\$4,910	No Bolt Kit		No Lift Kit		\$912	\$4,079
45	FK-MWDURAS-2-DD45	\$5,237	No Bolt Kit		No Lift Kit		\$971	\$4,365
50	FK-MWDURAS-2-DD50	\$5,783	No Bolt Kit		No Lift Kit		\$1,077	\$4,851
60	FK-MWDURAS-2-DD60	On request	No Bolt Kit		No Lift Kit		On request	On request



VIBRA-MAT

REDUCE HARVEST LOSS



PRIMARY
SALES AUSTRALIA

THE VIBRA-MAT ELIMINATES A MAJOR SOURCE OF HARVEST LOSSES ON YOUR RIGID FRONT



VIBRA-MATS ARE NOW AVAILABLE FOR CASE 3050, NH 760CG AND CLAAS VAR



VIBRA-MATS WITH EXTRA CENTRE-LAYER FOR MOST RIGID FRONTS

REPLACEMENT MAT (8 INCH DEEP)			HARDWARE KIT		FULL KIT (INCL. H/WARE)	
Size	Part #	\$ Each	Part #	\$ Each	Part #	\$ Each
20ft	VR20	\$341.00	VH20	\$244.00	VR/VH20	\$585.00
25ft	VR25	\$395.00	VR25	\$300.00	VR/VH25	\$695.00
30ft	VR30	\$444.00	VH30	\$364.00	VR/VH30	\$808.00
36ft	VR36	\$536.00	VH36	\$444.00	VR/VH36	\$980.00

Note: Extra depth mats (12" deep) and Double depth mats (16" deep) also available. Please call for pricing.

VIBRA-MATSWITH EXTRA CENTRE-LAYER FOR DUAL KNIFE F-NH 971 & NH 806

REPLACEMENT MAT			MAT & 971 SPECIAL BOLT KIT		MAT & 806 SPECIAL BOLT KIT	
Size	Part #	\$ Each	Part #	\$ Each	Part #	\$ Each
20ft	VRDK20	\$348.00	VRDK/ VBKit 20	\$409.00	VRDK/VH20	\$592.00
25ft	VRDK25	\$415.00	VRDK/ VBKit 25	\$490.00	VRDK/VH25	\$715.00
30ft	VRDK30	\$471.00	VRDK/ VBKit 30	\$561.00	VRDK/VH30	\$834.00

HARDWARE KIT

(hold-downs, bolts, nuts, washers and spacers)
Order Part No VH-16, 20, 25, 30 or 36 depending on the front width (in feet)
See VH parts prices above

BOLT KIT

(bolts, nuts, washers and spacers)
Order Part No. VB-Kit-16, 20, 25, 30, or 36 depending on the front width (in feet)
See VB parts prices above

THE HAY EXPRESS™

STOCKFEEDING IS NOW QUICK, SAFE & EASY!



FEATURES

- > Robust steel construction
- > 2 tonne rated load capacity
- > Stable, easy-to-tow design
- > Patented mechanism controls feeds-out-rate
- > Superior W A R N winch mechanism
- > Optional breakaway braking system and lights
- > Suitable for 4x4, 4x3 big square bales (with an optional kit for 3x3 bales)
- > Tandem load-sharing, roller-rocker spring assemblies

BENEFITS

- > One person operation
- > Considerable time and labour saving
- > Safety first (stay in the cab while feeding out)
- > Low maintenance
- > Wise investment compared with your current feed-out methods
- > Can be towed by any vehicle with a tow hitch
- > Feeds hay in “biscuits” so stock can feed from all directions with less trampling and wastage compared to windrows

THE HAY EXPRESS™

THE HAY EXPRESS™ UTE MOUNTED

THE “SON” OF HAY EXPRESS™ MOUNTS EASILY ON ANY SUBSTANTIAL FARM UTE, TO PROVIDE MEASURED DELIVERY OF HAY WHEN A TRAILER IS NOT PRACTICAL OR JUSTIFIED.

Made to the same high quality and durability as the tailed version and fitted with cordless remote control and a substantial winch.

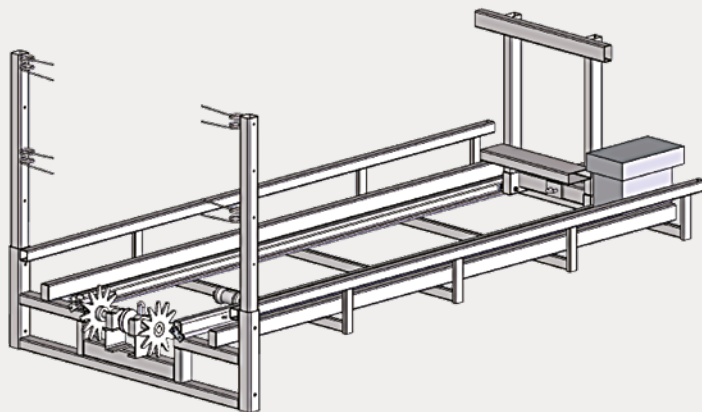

FOR MORE INFORMATION CONTACT YOUR DEALER OR PRIMARY SALES OFFICE
PRIMARYSALES.COM.AU/HAYEXPRESS



FOR HELP & MORE INFORMATION CALL YOUR PRIMARY SALES OFFICE

PRIMARYSALES.COM.AU 15

ADAPT-A-GAP™ CROP FINGER SYSTEM

SNAP-ON EXTENSIONS FOR ADJUSTING GAP WIDTH & ANGLE

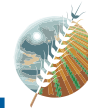

PRIMARY
SALES AUSTRALIA



CANADIAN, U.S. AND AUSTRALIAN PATENTS GRANTED

> SIMPLY "SNAP-ON" THE APPROPRIATE EXTENSIONS TO GIVE THE GAP WIDTH / ANGLE YOU WANT AND START RECOVERING THE GRAIN YOU HAVE PREVIOUSLY BEEN LEAVING BEHIND ON THE GROUND

> IN LIGHT CROP DENSITIES, CUT STALKS & HEADS CAN BE LOST OVER THE FRONT BECAUSE THERE IS INSUFFICIENT FIELD DENSITY TO STOP THEM FALLING FORWARD
> INTEGRATES WITH HWSC TO HELP INCREASE WEED SEED PICK UP

FIELD DENSITY FEEDS IN AT WIDTH "A" AND IS COMPRESSED TO WIDTH "B" FOR MUCH GREATER DENSITY AT THE KNIFE.

ADAPT-A-GAP™

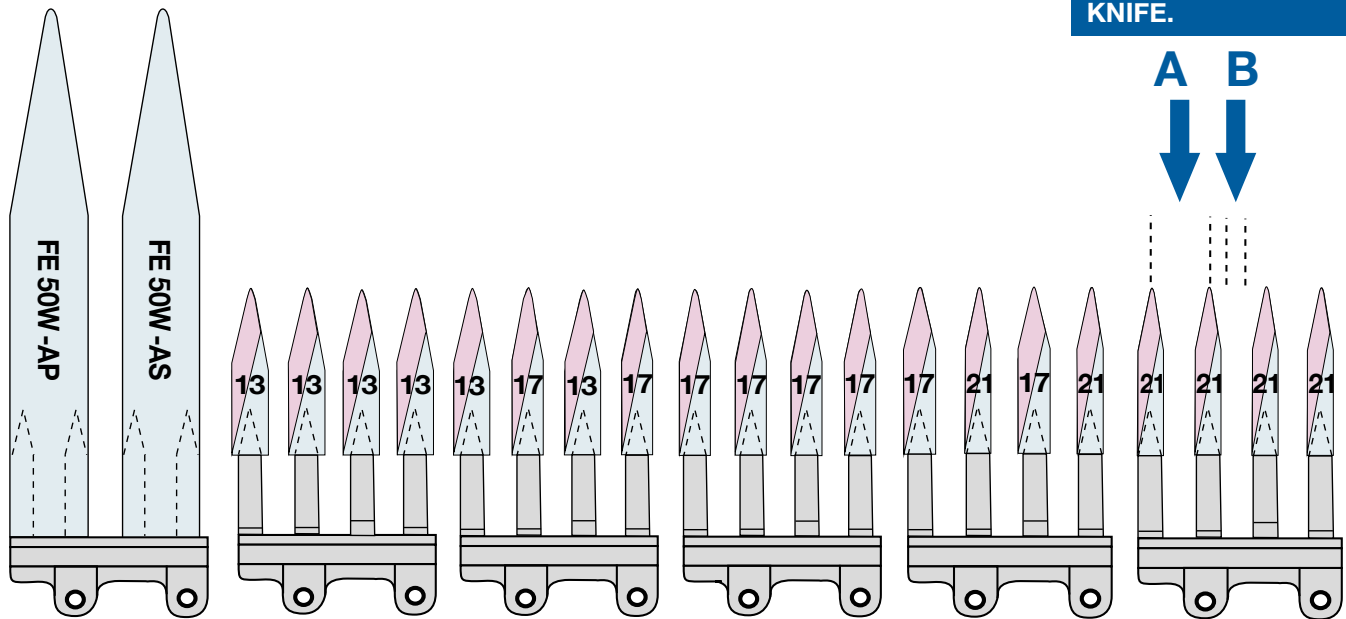

21MM GAP SETTING
USING PLATFORM EXTENDERS for SORGHUM LUPINS ETC, AND SHATTER-PRONE CROPS

13MM GAP SETTING
FE 13 (FE-13-3) extensions for CEREALS 6 BAGS/ACRE 1.2 TONNES/Ha

15MM GAP SETTING
alternate FE-13 (FE-13-3) with FE-17 (FE-17-3) extensions for CEREALS 6 - 9 BAGS/ACRE 1.2-1.8 TONNES/Ha

17MM GAP SETTING
FE 17 (FE 17-3) extensions for CEREALS 9-12 BAGS/ACRE 1.8-2.4 TONNES/ Ha

19MM GAP SETTING
alternate FE 17 (FE 17-3) with FE 21 (FE 21-3) extensions for CEREALS 12 - 15 BAGS/ACRE 2.4 - 3 TONNES/Ha

21MM GAP SETTING
FE 21 (FE-21-3) extensions for CEREALS OVER 15 BAGS/ACRE OVER 3 TONNES/Ha

3.62:1

2.93:1

2.54:1

2.24:1

2.00:1

1.81:1

CROP COMPRESSION RATIOS (BY WHICH FIELD DENSITY IS COMPRESSED AT THE KNIFE)

FIND \$85,000 YOU COULD BE LEAVING ON THE GROUND
DOWNLOAD THE "CROP LOSS" CALCULATOR

primarysales.com.au/crop-loss-calculator

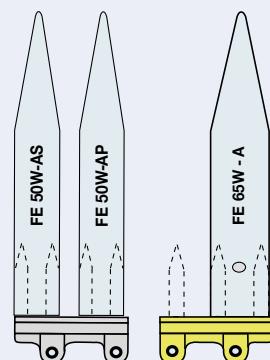

OPTIONAL EXTENSIONS

THESE OPTIONAL EXTENSIONS GREATLY BOOST THE FLEXIBILITY, CONVENIENCE AND EFFICIENCY WITH WHICH CROPS SUCH AS SORGHUM, LUPINS, SOY BEANS, CHICKPEAS AND FABA BEANS MAY BE PROFITABLY HARVESTED.

The system is very useful for combing-up wind or hail-damaged or tangled crops.

The angle adjustable version is the most popular, on which the catching area forward of the guard can be adjusted to positions which best suit most header front types and cutter bar positional requirements.

ADAPT-A-GAP™ CROP FINGER SYSTEM

CANADIAN, U.S. AND AUSTRALIAN PATENTS GRANTED

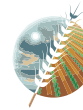

PRIMARY
SALES AUSTRALIA



The FE-13, 17, 21 and 30W (Blue) finger extensions are angled upwards to provide an ideal catching area on headers with downwards angled knives, directing crop into the front.



FE PICKUP-2
This light duty lifter is designed to pick up down or lodged crops



FE PICKUP-1
For lentils, peas and other ground-hugging crops



The FE 13-3, 17-3, 21-3 and new (30W-3) (Pink) fingers provide a straight extension of the knife guard. They are ideal for header knives which are relatively horizontal when lowered.



ANGLE ADJUSTABLE

REPLACEABLE WEAR STRIP
FS 10 X 8

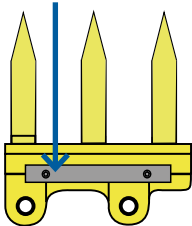

34MM GAP SETTING
Bare 3 finger guards for all crops

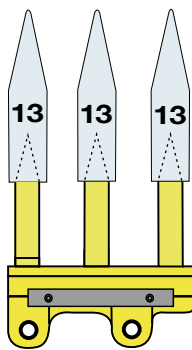

26MM GAP SETTING
FE-13 (FE-13-3) for lighter crops when using 2" centre guards
10 - 13 BAGS/ACRE

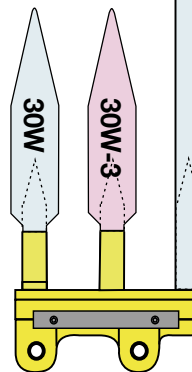

21MM GAP SETTING
FE-30W for lighter crops when using 2" centre guards
7 - 10 BAGS/ACRE

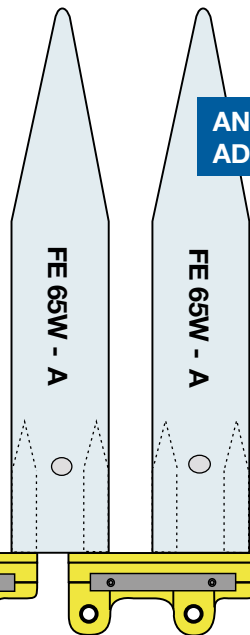

32MM GAP
Using FE 65W-A platform extenders on 2" centre guards for SORGHUM, LUPINS ETC, and SHATTER-PRONE CROPS

REPLACEABLE WEAR STRIP
FS 10 X 8

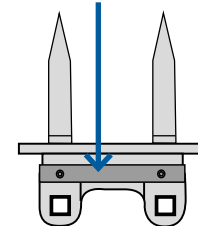

57MM GAP SETTING
Bare 2-finger guards for all crops

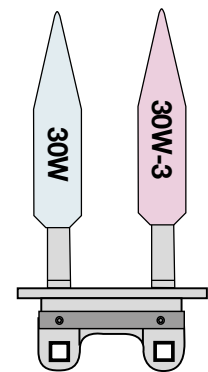

42MM GAP SETTING
For 2-finger guards in lighter crops, using FE-30W (blue) or FE-30W-3 (pink) extensions

ADAPT-A-GAP™

1.33:1

2.10:1

2.44:1

3.20:1

CROP COMPRESSION RATIOS (BY WHICH FIELD DENSITY IS COMPRESSED AT THE KNIFE)

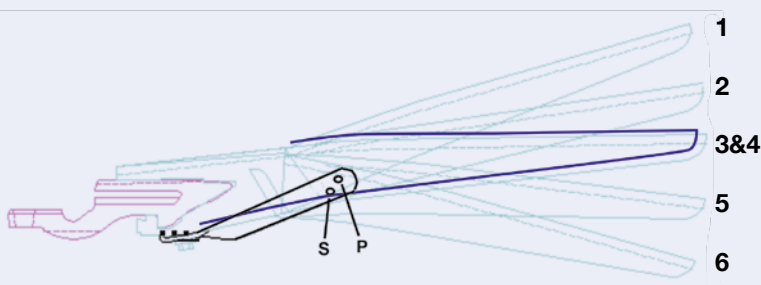

1 MAXIMUM UPLIFT (FE50WA-P)

USE ON HEADERS WITH DOWNWARD ANGLED KNIVES

2 MEDIUM UPLIFT (FE50WA-S)

IDEAL FOR KNIVES WHICH ARE RELATIVELY HORIZONTAL WHEN LOWERED

3&4 STRAIGHT (FE50WA-P/FE50WA-S)

5 MEDIUM PICKUP (FE50WA-P)

6 MAXIMUM PICKUP (FE50WA-S)

USE FOR COMBING UP OF DOWN AND TANGLED CROPS

PLATFORM EXTENDER FINGER OPTION

The metal clip uses one of 3 locating slots and choice of 2 hinging hole positions (using a roll-pin) to provide up to 6 angle settings. With the roll-pin assembled in the "P" position (best suited to Inter 1040/42/52, Case 1010/20, MacDon and Claas) angle positions 1, 3 and 5 are available. In the "S" position, angles 2, 4 and 6 are available (best suited to Honey Bee, John Deere, with 3" knife stroke, and most other popular fronts).



FOR HELP & MORE INFORMATION CALL YOUR PRIMARY SALES OFFICE

PRIMARYSALES.COM.AU

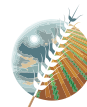

EXTENSION FINGERS (TO SUIT PSA GUARDS ONLY)

(FB Series I: 4 per guard, 8 per foot) (FG Series II: 3 per guard, 6 per foot) (FD Series III: 2 per guard, 4 per foot)



Part #	Blue, upward angled extensions for maximum crop recovery on most open fronts	\$ Each
FE 13	Reduces gap to 13mm	\$4.50
FE 17	Reduces gap to 17mm	\$4.50
FE 21	Reduces gap to 21mm	\$4.50
FE 30 W	30mm wide extensions for "FG" guard Option: Fit two sizes alternatively to achieve the gap you want	\$5.60



Part #	Pink, straight extensions for maximum crop recovery on knife guards which are relatively horizontal when lowered	\$ Each
FE 13-3°	Reduces gap to 13mm	\$4.50
FE 17-3°	Reduces gap to 17mm	\$4.50
FE 21-3°	Reduces gap to 21mm	\$4.50
FE 30W	30mm wide for 3-finger and 2-finger guards to reduce gap by 30mm Option: Fit two sizes alternatively to achieve the gap you want!	\$5.60
FT1	Fitting tool to cereal extensions	\$26.90

PLATFORM EXTENDERS

Part #	FE 50W & FE 65 W-A are 400mm long	\$ Each
FE 50W-AP	Angle adjustable extenders, maximum uplift, 50mm wide	\$37.90
FE 50W-AS	Angle adjustable extenders, optimum pick-up angle, 50mm wide	\$37.90
FT2	Fitting tool for FE 50 platform extenders	\$59.40
FE 65W-A	Angle adjustable extenders, 63mm wide for all fronts fitted with "FG" series 3-Finger guards	\$47.90
FT3	Fitting tool for FE 65W-A platform extenders	\$53.40

CROP LIFTER

FE PICKUP 1	Nylon Elastometer "Mini-Lifter" (190mm long, suit PSA guards) Suitable for lentils, peas and other ground-hugging crops. Good results are also obtained in longer crops	\$9.60
FE PICKUP 2	Light Duty Nylon Elastomer lifter (370mm long, suit PSA guards) Suitable for picking up down or lodged crops.	\$19.40



Note: These finger extensions have been designed to the highest standards. The fit has been modelled on Adapt-a-Gap guards from the current pattern. Some older (worn) guards may contribute to an imperfect fit.

HOW MANY PLASTIC FINGERS DO YOU NEED?

Front width (feet)	Extension Fingers			Platform Extenders		
	2 F/Guards	3 F/Guards	4 F/Guards	2 F/Guards	3 F/Guards	4 F/Guards
22	88	132	176	44	66	88
22½	90	x	180	43	x	90
24	96	x	192	48	x	96
25	100	150	200	50	75	100
26	104	x	208	52	x	104
30	120	180	240	60	90	120
35	140	210	280	70	105	140
36	144	216	288	72	108	144
39	156	x	312	78	x	158
40	160	240	320	80	120	160
45	180	270	360	90	135	180
50	200	300	400	100	150	200
60	240	360	480	120	180	240

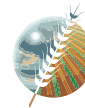

ADAPT- A- GAP KNIFE GUARDS (2 PER FT)

This price list shows the most popular of PSA harvest products, please contact PSA for unlisted prices & more information.

Part #	Four finger, FB Series guards (for 3" stroke knife drives)	\$ Each
FB1HB	Honeybee, Gleaner, Deutz, Belarus.	\$69.60
FB2	International 810 Series.	\$63.90
FB3	John Deere, New Holland, Laverda, M/Ferguson	\$73.20
FB3AGCO	Agco 600/5000/9000 Series fronts, with wear strip	\$93.30
FB36AGCO	Agco 600 Series front, without wear strip	\$57.80
FB40 M	Macdon, most Case IH, NH 840CD, H/Bee Top mount, Claas CS, Honeybee 4000 Series	\$61.30
Part #	Three finger, FG Series guards (for 4" stroke knife drives)	\$ Each
FG3JDTM	John Deere 900 Series Draper fronts with 4" knife stroke	\$60.80
FG40 M	2" centres guard for Macdon, Midwest, Case (modified) Honeybee 4000 Series	\$61.30
FG5	John Deere 600X/600R Series	\$51.50
Part #	Two finger, FD Series guards (for 3" stroke knife drives)	\$ Each
FD 40	New design for modern Case, Macdon, New Holland fronts	\$54.60

SPECIAL GUARDS Required for drive-ends, lift kits and where dual knives overlap. See previous kit listings (pg 3-13)

Part #	\$ Each	Part #	\$ Each	Part #	\$ Each
FB1HBDE	\$88.10	FB4-3M	\$61.80	FB48-4	\$64.40
FB1HBKOC	\$107.30	FB4M-KH	\$54.10	FB 49-5	\$117.60
FB1-3HBDE	\$106.20	FB4MKH-C	\$75.60	FG 3JD KH	\$67.30
FB1-4HBDE	\$117.80	FB4-3M-KH-L	\$61.80	FG 3JD KO-C	\$66.70
FB3-3Agco	\$91.80	FB 4-3 M-KH-R	\$61.80	FG 3JD-KH-LH	\$131.60
FB3AgcoDE	\$87.10	FB 40 M-KO-C*	\$98.90	FG 3JD-KH-RH	\$131.60
FB3-3AgcoDE	\$91.90	FB 40 M-CEG	\$100.70	FG 4 M	\$53.60
FB3-4AgcoDE	\$91.90	FB 41 M3	\$68.80	FG 40 M-KO-C**	\$98.90
FB30	\$79.10	FB 42 M4	\$58.80	FD4M-1	\$73.10
FB31	\$78.10	FB 43-3 M	\$62.90	FD4M-13	\$46.40
FB32-3	\$82.80	FB 43-CD-LH	\$75.40	FD4M-KHL	\$58.80
FB33-5	\$139.80	FB 44-CD-RH	\$70.60	FD4M-KHR	\$58.80
FB34-5	\$150.10	FB 46-CD-KOC 02	\$171.00	FD40-KOC (assy)	\$215.40
FB35-5	\$148.80	FB 46-4	\$69.50	*FB 40 M KOC-TP repl. top plate / screws	\$20.10
FB36-3Agco	\$80.40	FB 47-5-KOC	\$161.70	**FG 40 M KOC-TP repl. top plate / screws	\$15.50
FB37-6	\$165.30	FB 47-CL-DE-2	\$119.40		
FB4M	\$53.60				
FB3AgcoKO-C*	\$122.70				

This price list shows only the most popular of PSA harvest products. Please contact PSA for unlisted prices and further enquiries.

OTHER PARTS

FS 10 x 8 WEAR STRIP Hardened, replaceable, with screws and washers	\$10.30
FS 3 x 25 Shim	\$4.20
KNIFE DRIVE ARMS: F-CNH-KDA-01 suits Case 3152, NH 840CD	\$702.50
KNIFE HEADS: F-M-KH-STD suits Case IH 2052, Macdon 973	\$386.30
KNIFE HEADS: F-M-KH-5LH or RH suits Case IH 2152, Macdon D60/D65	\$393.80
KNIFE HEADS: F-JDD-KH-635 suits JD 635D and 640D (2 per machine)	\$555.00
KNIFE HEADS: F-AGCO-9250-KH (fts L & R hand) suits Agco 9250	\$399.20
V-HDCLIP VIBRA - MAT Hold-down clips	\$9.80



STOP WEEDS IN THEIR TRACKS

- > REDUCES WEED SEED GERMINATION
- > ADJUSTABLE FOR DIFFERENT WHEEL TRACK WIDTH
- > MODELS AVAILABLE FOR MOST COMBINE MAKES & SERIES
- > VERY AFFORDABLE AND EASY MAINTENANCE
- > MINIMAL IMPACT ON COMBINE PERFORMANCE
- > EASY LOW COST TRANSFER BETWEEN MOST SERIES/
MODELS³
- > REDUCE DUST FOR SPRAYING¹
- > SUITABLE FOR RTK/A&B LINING AND CTF. IMPROVE YOUR
SPRAY PROGRAM BY UP TO 80%²

¹ GRDC GroundCover™ 133 March 2018

² Weedsmart March 21 2018

³ Please check with us

IMPROVE YIELD BY REDUCING WEED COMPETITION

Add the EMAR Chaff Deck to your weed control tool kit & stop spreading weed seeds out the back of your combine harvester



Order from chaffdeck.com today

(08) 9462 1910
SALES@PRIMARYSALES.COM.AU

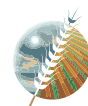

PRIMARY
SALES AUSTRALIA

THE GOLD STANDARD IN FEED DRUM TECHNOLOGY

iPaddock
TYPHOON



**BONUS
FREE
TWISTER
\$5995_{incGST}**



Stops the drive chain coming off; installed in just minutes. Also available online at \$149. Patent applied.

iPaddock Typhoon™ is the all-new, next generation feed drum from iPaddock. Save time and money by direct heading your crops, without the slow speeds, blockages and breakdowns common with draper fronts.

Now available for Macdon D1, CA20, CA25, and ALL NEW for John Deere 6 & 7 series

1300 464 040
ipaddock.com.au/typhoon



TERMS AND CONDITIONS

Terms and conditions relating to purchases of Primary Sales product are available from our website.

PART RETURN POLICY

Within 14 days of invoice date - No penalty.

14 days plus of invoice date - A restocking fee may be charged depending on circumstances.

After 90 days - Non-refundable.

PRICES

This Harvest Dealer Guide shows GST-exclusive recommended retail popular Primary Sales harvest products which are effective 1st July, 2020 and are subject to change without notice. Product specifications may also change without notice as a result of our commitment to product development.

WARRANTY

Original purchasers of all new Primary Sales products enjoy the protection of the statutory provisions of the trade practices act.

As the set-up and use of tillage, seeding and harvesting equipment is affected by variables beyond our control, neither the Manufacturer nor any person employed on its behalf - including dealers or agents - are liable for any loss or damage, whether consequential or otherwise, resulting from the use of its products.

Warranty may/may not apply where any product is used for other than its intended and recommended purpose, or is subjected to pressures, loads or conditions beyond that for which it is designed. Should a product not perform its intended or recommended function, contact the supplying Dealer (your place of purchase).

PRIMARYSALES.COM.AU

PRIMARY
SALES AUSTRALIA



TRADING TERMS



FOR HELP & MORE INFORMATION CALL YOUR PRIMARY SALES OFFICE

PRIMARYSALES.COM.AU **21**

MORE GRAIN IN THE BIN LESS IN THE FIELD

SAVINGS
(BARLEY)
\$35,000
8% TO 3% LOSS
IN 1,000 Ha
PROGRAM 2T/Ha

BUSHEL PLUS™

FAST & SAFE COMBINE HARVEST LOSS CALIBRATION

- > IMPROVE PROFIT - HELPS MANAGE GRAIN LOSS VS RUNNING COSTS
- > FITS ANY COMBINE WITH NO BOLTING OR WIRING REQUIRED
- > REMOTE CONTROL RELEASE FOR SAFE & EASY OPERATION
- > SEPARATOR UNIT SEPARATES GRAIN FROM CHAFF IN SECONDS
- > TWO SIZE DROP PANS FOR VARIOUS CROP CONDITIONS
- > ACCURACY FROM THE PATENTED COVER DESIGN, PREVENTING KERNELS FROM ENTERING SAMPLE PAN BEFORE USE
- > UNIQUE DROP PAN DESIGN ALLOWS CALIBRATION FOR LIME, COMPOST & OTHER FERTILISER SPREADERS
- > DROP OR SPREAD YOUR STRAW FOR TESTING
- > CHAFF DECK OPTION AVAILABLE

"(Bushel Plus) system is a great boon to my farm, as it not only saves me time, but also money in the long run"

Ian Coleman
(Farmer, Katanning)

"With this easy monitoring system we are able to keep our losses very low. For our program alone (it) equates to about \$32,000 a year in potential savings"

Scott Angwin
(Farmer, Wagin)

"I can confirm this thing (Bushel Plus) is gold. It is the difference between harvest loss measurements being taken or not"

Peter Newman
(Agronomist, Planfarm Project)

HARVEST LOSS TEST

BEFORE

168KGS PER
HECTARE



AFTER

35KGS PER
HECTARE

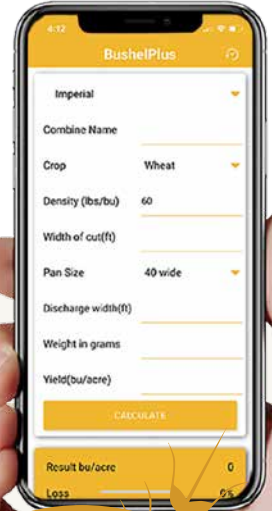

DO IN FOUR TO FIVE MINUTES WHAT
USED TO TAKE 40 MINUTES

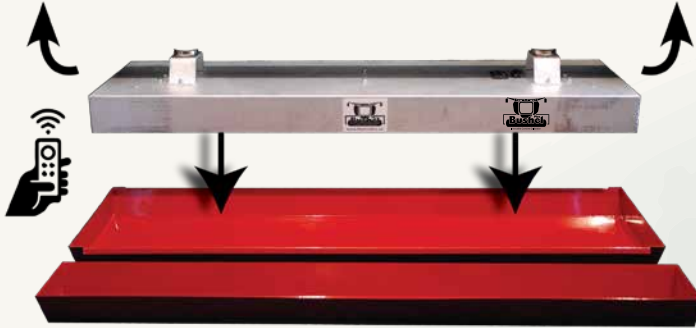

REMOTE CONTROL RELEASE

INTEGRATED
APP FOR QUICK
& EASY LOSS
CALCULATION



COMPLETE SYSTEM INCLUDES

- > MAIN COVER (ATTACHES TO COMBINE)
- > TWO DIFFERENT SIZE DROP PANS
- > VARIABLE SPEED SEPERATOR FOR FAST SAMPLE CLEANING
- > TWO REMOTES WITH LANYARD
- > DURABLE FIELD SCALE
- > 12 VOLT SMART CHARGER
- > MANUAL



Optimize Your Combine



FOR HELP & MORE INFORMATION CALL YOUR PRIMARY SALES OFFICE

PRIMARYSALES.COM.AU **23**

BUSHEL PLUS™

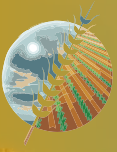

PRIMARY
SALES AUSTRALIA

HARVEST DEALER GUIDE 2020

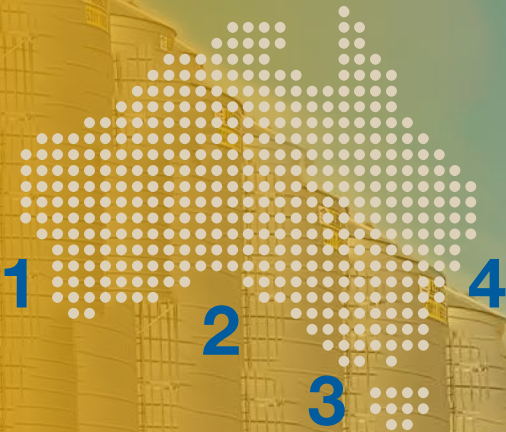

NATIONAL
CUSTOMER SERVICE
(08) 9462 1910
SALES@PRIMARYSALES.COM.AU

1 WESTERN AUSTRALIA
MICHAEL BAILEY
0407 990 794
(08) 9250 3500
SALES@PRIMARYSALES.COM.AU

2 SOUTH AUSTRALIA
KEITH HOPKINS
0428 990 973
(08) 8345 4118
ADELAIDE@PRIMARYSALES.COM.AU

3 VICTORIA & SOUTHERN NEW SOUTH WALES
BRIAN LEGG
0436 608 435
(08) 8345 4118
BENDIGO@PRIMARYSALES.COM.AU

4 CENTRAL & NORTHERN NEW SOUTH WALES & QUEENSLAND
WARRICK FINLAY
0429 779 473
(02) 6882 2844
DUBBO@PRIMARYSALES.COM.AU

PRIMARY SALES AUSTRALIA
PTY. LTD ABN 90 608 575 051

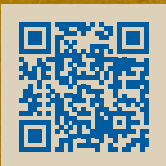

TWITTER



YOUR DEALER

PRIMARYSALES.COM.AU